

Doorsmith

Your Complete Door Source



INTERIOR DOORS PRICING

PUBLISHED DATE: MAR 2025

***Doorsmith* DIGITAL**
COMPLETE DOOR QUOTING SOFTWARE

FOR ALL OF YOUR DOOR PRICING NEEDS
ASK YOUR DOORSMITH SALES REPRESENTATIVE

doorsmith.ca • 1.800.461.5411 • support@doorsmith.ca

CanSave/Doorsmith Freight Policy

All freight policies are subject to change without notice

AREAS SERVICED BY CANSAVE TRUCK RUNS

ZONE 1: ONTARIO (South, Central, S. West, East to Near North)

- Weekly delivery
- 3% Freight charge on CanSave truck runs
- No minimum order
- \$20 minimum freight charge per sales order

ZONE 2: NEAR NORTH (Highway 11 Cochrane to Hearst)

- Bi-weekly delivery
- 5% Freight charge applies on all orders
- No minimum order
- \$40 minimum freight charge per sales order

ZONE 3: NORTHERN ONTARIO (North of Sault St. Marie including Thunder Bay)

- Weekly delivery
- 13% Freight charge on CanSave truck runs
- No minimum order
- \$100 minimum freight charge per sales order

AREAS NOT SERVICED BY CANSAVE TRUCK RUNS

Freight will be quoted and billed separately - \$500 minimum

MARITIMES AND QUEBEC

- \$40 per cabinet freight charge on Cabinetsmith (\$1500 minimum order)
- Warranty cabinets will be shipped with the next full freight shipment
- Non-cabinet orders will be quoted and billed

NEWFOUNDLAND & LABRADOR & P.E.I.

- Orders will be quoted and billed -or-
- F.O.B any destination to the Maritimes with cabinet charges -minimum \$1500 -or-
- F.O.B Barrie - no minimum order - no freight charge

ADDITIONAL CHARGES

Dealers without 53ft truck access, requiring tailgate delivery (ie. No forklift), will be quote and bill

PICK UP FROM CANSAVE BARRIE (On demand)

- Please arrange in advance for a set pick up time

PICK UP FROM HUBS

- 3% freight charge / \$20 minimum order
- Hub locations: London, Ottawa, Sudbury, Timmins

Table of Contents

MOULDED & FLUSH		Pages. 4-24	SHAKER		Pages. 29-34
Outer Stiles Door Machining Chart	p.4		Shaker System Information	p.29	
Moulded & Flush System Information	p.5		Shaker Interior Profile Reference	p.30	
Moulded Interior Profile Reference	p.6		<i>Shaker</i> / 7910, 7920, 794H, 7935, 792A, 793H, 795H, 7936	p.31	
Colonist Textured	p.7		<i>Shaker</i> / 793A, 793E, 794F, 794Z, 793K, 793L, 794L, 795L	p.32	
Camden	p.8		<i>Raised Panel Shaker</i> / 2010, 2020, 202A, 203H, 203L, 203A, 203E, 203K, 2035, 2036, 2040, 204H	p.33	
Carrara	p.9		<i>Raised Panel Shaker</i> / 204F, 204L, 204Z, 205H, 205L, 206R, 206T, 2050, 2060, 2080	p.34	
Sante-Fe	p.10				
Rockport	p.11				
Craftsman	p.12				
Madison	p.13				
Monroe	p.14				
Birkdale	p.15				
Conmore	p.16				
Primed Hardboard	p.17				
Mahogany	p.18				
1-3/4" Solid Core Doors	p.19				
1-3/4" Fire Rated Doors	p.20				
DayBar Steel Doors	p.21				
Pocket Door Kits & Hardware	p.22				
Closet Bypass Hardware	p.23				
Barn Door Hardware	p.24				
Barn Doors	p.24				
FRENCH DOORS		Pages. 25-28	SPECIAL ORDER FRENCH		Pages. 35-36
French Door System Information	p.25		Shaker & Solid Wood Profile Reference / French Glass Options	p.35	
Wood Divider Reference Chart	p.26		One-Lite / Multi-Lite / Shaker French / Solid Wood Door Options	p.36	
French Door Profile Reference	p.27				
<i>Ovolo Models</i> / 3050, 3100, 3150, 303H, 304H, 305H, 1000	p.28				
<i>Shaker Models</i> / 803H, 804H, 805H, 6000	p.28				
			QUICKSHIP FRENCH DOORS	Pages. 37-44	
			QUICKSHIP French Profile Reference	p.37	
			QUICKSHIP System Information	p.38	
			<i>1-3/8" Primed Shaker</i> / 8401, 8402, 8433, 8444, 8405	p.39	
			<i>1-3/4" Primed Shaker</i> / 8401, 8402, 8433, 8444, 8405	p.39	
			<i>1-3/8" Primed French Shaker</i> / 8401, 8433, 8444, 8405	p.40	
			1-3/8" Louver Doors	p.40	
			<i>One Lite Model 1501</i> / DWL 1 Lite, Harlow, Pantry, Lexington	p.41	
			<i>One Lite Model 1501</i> / Modena, Madison, Clear 1 Lite, Mirror 2 Sides, Bevelled 10/15 Lite, Flat Glue Chip, Mirror 1 Side, Riverston Obscure	p.42	
			<i>One Lite Model 1501</i> / Sable, Open & Beaded, Narrow Read, Adelaide, Wheat, Laundry, Rain, Artisan	p.43	
			<i>One Lite Model 1501</i> / Delta Frost, Pin Head, Screen Dot, Seedy Baroque, Heavy Water, Kasumi	p.44	

Outer Stiles -



Interior Machining Chart

Door Model		12"	14"	16"	18"	20"	22"	24"	26"	28"	30"	32"	34"	36"
COLONIST TEXTURED	80"	2 1/2	3 1/2	4 1/2	3 1/16	4 1/16	3 3/16	4 3/16	5 3/16	4 3/16	4 3/16	4 3/16	5 3/16	4 3/16
	84"	2 1/2	3 1/2	4 1/2	3 1/16	4 1/16	3 3/16	4 3/16	4 3/16	4 3/16	4 3/16	4 3/16	5 3/16	4 3/16
	96"	x	x	3 1/16	3 1/16	4 1/16	3 3/16	4 3/16	3 3/16	4 3/16	4 3/16	4 3/16	5 3/16	4 3/16
CAMDEN	80"	2 11/16	3 1/4	4 1/4	4 1/4	5 1/4	3 1/2	4 1/2	5 1/2	5	5 5/32	4 5/8	5 5/8	5 9/16
	84"	x	x	x	x	x	x	x	x	x	x	x	x	x
	96"	x	x	x	x	x	x	x	x	x	x	x	x	x
CARRARA	80"	2 11/16	3 11/16	4 11/16	3 7/32	4 7/32	3 11/32	4 11/32	5 11/32	5 11/32	5 11/32	5 11/32	6 11/32	6 11/32
	84"	2 11/16	3 11/16	4 11/16	3 7/32	4 7/32	3 11/32	4 11/32	5 11/32	5 11/32	5 11/32	5 11/32	6 11/32	6 11/32
	96"	x	x	4 11/16	3 7/32	4 7/32	3 11/32	4 11/32	5 11/32	5 11/32	5 11/32	5 11/32	6 11/32	6 11/32
ROCKPORT	80"	3 1/16	2 9/16	3 9/16	3 7/8	4 7/8	3 1/8	4 1/8	3 1/8	4 1/8	4 1/8	4 1/8	4 1/8	5 1/8
	84"	x	x	3 9/16	3 7/8	4 7/8	3 1/8	4 1/8	3 1/8	4 1/8	4 1/8	4 1/8	4 1/8	5 1/8
	96"	x	x	3 3/4	4 3/4	5 3/4	3 3/4	4 3/4	3 3/4	4 3/4	4 3/4	4 3/4	5 3/4	5 1/8
SANTA FE	80"	2 1/2	3 1/2	4 1/2	4	5	4	5	4	5	4 1/2	4 1/2	5	6
	84"	x	x	x	4	5	4	5	4	5	4 1/2	4 1/2	5	6
	96"	x	x	4 1/2	4	5	4	5	4	5	4 1/2	4 1/2	5	6
CRAFTSMAN	80"	3	4	3 7/8	4	5	6	4 1/2	4 1/2	5 1/2	4 1/2	5 1/2	4 1/2	5 1/2
	84"	3	4	3 7/8	4	5	6	4 1/2	4 1/2	5 1/2	4 1/2	5 1/2	4 1/2	5 1/2
	96"	x	x	x	x	x	x	x	x	x	x	x	x	x
MADISON	80"	3 5/16	4 5/16	4	5	4 1/4	5 1/4	4 1/4	5 1/4	4 3/4	4 3/4	4 3/4	5 3/4	4 3/4
	84"	3 5/16	4 5/16	4	5	4 1/4	5 1/4	4 1/4	5 1/4	4 3/4	4 3/4	4 3/4	5 3/4	4 3/4
	96"	x	x	4	5	4 1/4	5 1/4	4 1/4	5 1/4	4 3/4	4 3/4	4 3/4	5 3/4	4 3/4
MONROE	80"	3	3 1/4	3 3/8	4 3/8	4 1/4	5 1/4	4 1/4	5 1/4	4 3/4	4 3/4	4 3/4	5 3/4	4 3/4
	84"	3	3 1/4	3 3/8	4 3/8	4 1/4	5 1/4	4 1/4	5 1/4	4 3/4	4 3/4	4 3/4	5 3/4	4 3/4
	96"	x	x	x	4 3/8	4 1/4	5 1/4	4 1/4	5 1/4	4 3/4	4 3/4	4 3/4	5 3/4	4 3/4
CONMORE	80"	2 5/8	2 7/16	3 7/16	4 1/8	5 1/8	3 1/8	4 1/8	5 1/8	4 1/8	4 1/8	4 1/8	5 1/8	5 1/8
	84"	2 5/8	2 7/16	3 7/16	4 1/8	5 1/8	3 1/8	4 1/8	5 1/8	4 1/8	4 1/8	4 1/8	5 1/8	5 1/8
	96"	x	x	x	4 3/16	5 3/16	3 3/16	4 3/16	5 3/16	4 3/16	4 3/16	4 3/16	5 3/16	5 3/16
BIRKDALE	80"	3	3 1/4	3 3/8	4 3/8	4 1/4	5 1/4	4 1/4	5 1/4	4 3/4	4 3/4	4 3/4	5 3/4	4 3/4
	84"	x	x	3 3/8	4 3/8	4 1/4	5 1/4	4 1/4	5 1/4	4 3/4	4 3/4	4 3/4	5 3/4	4 3/4
	96"	x	x	x	4 3/8	4 1/4	5 1/4	4 1/4	5 1/4	4 3/4	4 3/4	4 3/4	5 3/4	4 3/4
		Under the minimum required for lock machining												
	x	Not available												
		Min.doors with openings: backset 2.3/8" = 4" incl, 2.3/4" = 4.3/8" incl												
		Mirror door = use smallest value between Madison and model ordered												
		Executive Series subtract 13/16"												

MOULDED & FLUSH



Upgrade Slabs to a System



Fully Assembled (4^{5/8}" FA

- Prehung - ready to install
- Door and jambs machined for left or right handing
- Hinges are 3-1/2" Radius
- All single doors styles available (double doors not available)



Knock Down (4^{5/8}" KD

- Shipped knock down inside shrink wrapped packaging
- Door and jambs machined for left or right handing
- Hinges are 3-1/2" Radius
- All single and double doors available



Reversible (4^{9/16}" RV *Not Available in 6^{5/8}"

- All components machined, shipped knock down inside shrink wrapped packaging
- Hinges are 3" x 3-3/16" Square with 5/8 Radius
- Door and jambs machined reversible - handing not required
- Available in Colonist Textured, or Primed Hardboard in select sizes

System Upgrade Pricing / Pick your frame & add it to the cost of your door Slab

JAMB UPGRADES	BASE SYSTEM ADDERS				BIFOLD JAMB UPGRADES	BASE SYSTEM ADDERS			
	78"	80"	84"	96"		78"	80"	84"	96"
4 ^{5/8} " Primed Finger Joint (Standard)	+\$215	+\$215	+\$310	+\$310	4 ^{5/8} " Primed Finger Joint (Standard)	+\$175	+\$175	+\$260	+\$260
6 ^{5/8} " Primed (FJ)	+\$310	+\$310	+\$410	+\$410	6 ^{5/8} " Primed (FJ)	+\$260	+\$260	+\$360	+\$360
4 ^{5/8} " Clear Pine (Mahogany in 80" only)	+\$345	+\$345	+\$415	+\$415	4 ^{5/8} " Clear Pine (Mahogany in 80" only)	+\$295	+\$295	+\$365	+\$365
6 ^{5/8} " Clear Pine	+\$450	+\$450	N/A	N/A	6 ^{5/8} " Clear Pine	+\$400	+\$400	N/A	N/A
4 ^{5/8} " Oak	+\$380	+\$380	+\$455	+\$455	4 ^{5/8} " Oak	+\$330	+\$330	+\$405	+\$405
6 ^{5/8} " Oak	+\$660	+\$660	+\$760	+\$760	6 ^{5/8} " Oak	+\$610	+\$610	+\$710	+\$710
Double Doors	Standard with Ball Catch Matching Hinge Colour				FULL DOOR SYSTEM X 2				
Double Doors	Flush Bolt Upgrade				+\$20	+\$20	+\$20	+\$20	

Hinge Colours Available

Satin Nickel / Brass / Antique Nickel / Antique Brass / Brushed Chrome / Venetian Bronze / White / Black

Recommended System Rough Stud Opening (RSO): To determine an appropriate RSO for our Doorsmith Systems, add 2 – 2 1/2" inches to the width and 2" to the height of any slab size.

Moulded Interior Door Profile Reference

(Custom sizing available)

SMOOTH

DOORS ARE AVAILABLE 1-3/8" & 1-3/4" THICK - IN HOLLOW CORE OR UPGRADE TO **PROCORE** THE QUIET DOOR™



SMOOTH - FLAT PANEL DOORS

DOORS ARE AVAILABLE 1-3/8" & 1-3/4" THICK - IN HOLLOW CORE OR UPGRADE TO **PROCORE** THE QUIET DOOR™

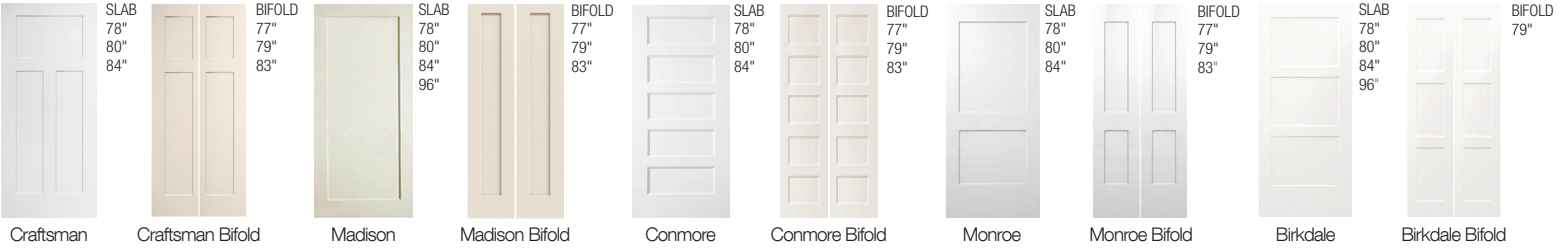

WOOD GRAIN

DOORS ARE AVAILABLE 1-3/8" & 1-3/4" THICK - IN HOLLOW CORE OR UPGRADE TO **PROCORE** THE QUIET DOOR™



FLUSH DOORS

Available in: Primed Hardboard / Mahogany

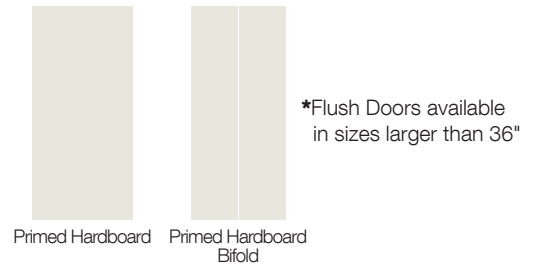

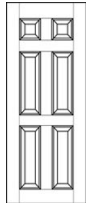

Colonist Textured

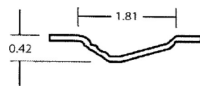

- **Slab: 6 Panel Textured** (Cove and Bead Sticking)
- Fully Assembled/Knock Down Systems available (*Need handing*)
- *Reversible Systems available in 78"/80" only **MARKED BY BOLD PRICING**

Shaded Blue Areas Denote Stock

DOORS

	Width	Height			
		78"	80"	84"	96"
1-3/8" HOLLOW CORE	12"	\$146	\$146	\$251	N/A
	14"	\$146	\$146	\$251	N/A
	16"	\$146	\$146	\$251	\$376
	18"	\$146	\$146	\$251	\$376
	20"	\$154	\$154	\$259	\$384
	22"	\$154	\$154	\$259	\$384
	24"	\$154	\$154	\$259	\$384
	26"	\$159	\$159	\$264	\$389
	28"	\$159	\$159	\$264	\$389
	30"	\$159	\$159	\$264	\$389
	32"	\$172	\$172	\$277	\$402
	34"	\$182	\$182	\$287	\$412
	36"	\$182	\$182	\$287	\$412

4-5/8" SYSTEMS (FA/KD/RV*)

		Height			
		78"	80"	84"	96"
	78"	\$313	\$313	\$561	N/A
	80"	\$313	\$313	\$561	N/A
	84"	\$313	\$313	\$561	\$686
	96"	\$313	\$313	\$561	\$686
	108"	\$321	\$321	\$569	\$694
	120"	\$321	\$321	\$569	\$694
	132"	\$321	\$321	\$569	\$694
	144"	\$326	\$326	\$574	\$699
	156"	\$326	\$326	\$574	\$699
	168"	\$326	\$326	\$574	\$699
	180"	\$339	\$339	\$587	\$712
	192"	\$349	\$349	\$597	\$722
	204"	\$349	\$349	\$597	\$722

DOORS

	Width	Height			
		78"	80"	84"	96"
1-3/8" PRO CORE	12"	\$371	\$296	\$401	N/A
	14"	\$371	\$296	\$401	N/A
	16"	\$371	\$296	\$401	\$526
	18"	\$371	\$296	\$401	\$526
	20"	\$379	\$304	\$409	\$534
	22"	\$379	\$304	\$409	\$534
	24"	\$379	\$304	\$409	\$534
	26"	\$384	\$309	\$414	\$539
	28"	\$384	\$309	\$414	\$539
	30"	\$384	\$309	\$414	\$539
	32"	\$397	\$322	\$427	\$552
	34"	\$407	\$332	\$437	\$562
	36"	\$407	\$332	\$437	\$562

4-5/8" SYSTEMS (FA/KD)

		Height			
		78"	80"	84"	96"
	78"	\$586	\$511	\$711	N/A
	80"	\$586	\$511	\$711	N/A
	84"	\$586	\$511	\$711	\$836
	96"	\$586	\$511	\$711	\$836
	108"	\$594	\$519	\$719	\$844
	120"	\$594	\$519	\$719	\$844
	132"	\$594	\$519	\$719	\$844
	144"	\$599	\$524	\$724	\$849
	156"	\$599	\$524	\$724	\$849
	168"	\$599	\$524	\$724	\$849
	180"	\$612	\$537	\$737	\$862
	192"	\$622	\$547	\$747	\$872
	204"	\$622	\$547	\$747	\$872

BI-FOLD DOORS

	Width	Height				
		77"	79"	83"	95"	
1-3/8" BI-FOLDS	18"	\$194	\$194	\$299	N/A	
	20"	\$194	\$194	\$299		
	22"	\$194	\$194	\$299		
	24"	\$194	\$194	\$299		
	26"	\$210	\$210	\$315		
	28"	\$210	\$210	\$315		
	30"	\$210	\$210	\$315		\$440
	32"	\$228	\$228	\$333		\$458
	34"	\$228	\$228	\$333		\$458
	36"	\$228	\$228	\$333		\$458

JAMB UPGRADES FOR SYSTEMS

System	+95	+95	+100	+100
6-5/8" Primed (FJ)				
4-5/8" Clear Pine/ (Mahogany in 80"only)	+130	+130	+105	+105
6-5/8" Clear Pine	+235	+235	N/A	N/A
4-5/8" Oak	+165	+165	+145	+145
6-5/8" Oak	+445	+445	+450	+450

ADDERS & UPGRADES

Slab only machining for 3 hinges & lock	\$17
Off Standard	\$215
Off Standard System (75" and up)	\$225
Off Standard System (73-75")	\$275

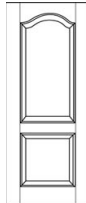

Camden



- **Slab: 2 Panel Textured** (Cove and Bead Sticking)
- Fully Assembled/Knock Down Systems available (*Need handing*)

Shaded Blue Areas Denote Stock

DOORS

	Width	78" Height	80" Height	84" Height	96" Height
	1-3/8" HOLLOW CORE	12"	\$146	\$146	
14"		\$146	\$146		
16"		\$146	\$146		
18"		\$146	\$146		
20"		\$154	\$154		
22"		\$154	\$154		
24"		\$154	\$154	N/A	N/A
26"		\$159	\$159		
28"		\$159	\$159		
30"		\$159	\$159		
32"		\$172	\$172		
34"		\$182	\$182		
36"		\$182	\$182		

4-5/8" SYSTEMS (FA/KD/RV*)

	78" Height	80" Height	84" Height	96" Height
	\$313	\$313		
	\$313	\$313		
	\$313	\$313		
	\$313	\$313		
	\$321	\$321		
	\$321	\$321		
	\$321	\$321	N/A	N/A
	\$326	\$326		
	\$326	\$326		
	\$326	\$326		
	\$339	\$339		
	\$349	\$349		
	\$349	\$349		

DOORS

	Width	78" Height	80" Height	84" Height	96" Height
	1-3/8" PRO CORE	12"	\$371	\$296	
14"		\$371	\$296		
16"		\$371	\$296		
18"		\$371	\$296		
20"		\$379	\$304		
22"		\$379	\$304	N/A	N/A
24"		\$379	\$304		
26"		\$384	\$309		
28"		\$384	\$309		
30"		\$384	\$309		
32"		\$397	\$322		
34"		\$407	\$332		
36"		\$407	\$332		

4-5/8" SYSTEMS (FA/KD)

	78" Height	80" Height	84" Height	96" Height
	\$586	\$511		
	\$586	\$511		
	\$586	\$511		
	\$586	\$511		
	\$594	\$519		
	\$594	\$519	N/A	N/A
	\$594	\$519		
	\$599	\$524		
	\$599	\$524		
	\$599	\$524		
	\$612	\$537		
	\$622	\$547		
	\$622	\$547		

BI-FOLD DOORS

	Width	77" Height	79" Height	83" Height	95" Height
	1-3/8" BI-FOLDS	18"	\$194	\$194	
20"		\$194	\$194		
22"		\$194	\$194		
24"		\$194	\$194		
26"		\$210	\$210	N/A	N/A
28"		\$210	\$210		
30"		\$210	\$210		
32"		\$228	\$228		
34"		\$228	\$228		
36"		\$228	\$228		

JAMB UPGRADES FOR SYSTEMS

6-5/8" Primed (FJ)	+95	+95	+100	+100
4-5/8" Clear Pine/ (Mahogany in 80"only)	+130	+130	+105	+105
6-5/8" Clear Pine	+235	+235	N/A	N/A
4-5/8" Oak	+165	+165	+145	+145
6-5/8" Oak	+445	+445	+450	+450

ADDERS & UPGRADES

Slab only machining for 3 hinges & lock	\$17
Off Standard	\$215
Off Standard System (75" and up)	\$225
Off Standard System (73-75")	\$275

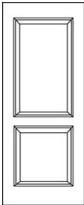

Carrara

- Slab: 2 Panel Smooth
- Fully Assembled/Knock Down Systems available (Need handing)

Shaded Blue Areas Denote Stock

DOORS

	Width	Height			
		78" Height	80" Height	84" Height	96" Height
1-3/8" HOLLOW CORE	12"	\$146	\$146	\$251	N/A
	14"	\$146	\$146	\$251	N/A
	16"	\$146	\$146	\$251	N/A
	18"	\$146	\$146	\$251	\$376
	20"	\$154	\$154	\$259	\$384
	22"	\$154	\$154	\$259	\$384
	24"	\$154	\$154	\$259	\$384
	26"	\$159	\$159	\$264	\$389
	28"	\$159	\$159	\$264	\$389
	30"	\$159	\$159	\$264	\$389
	32"	\$172	\$172	\$277	\$402
	34"	\$182	\$182	\$287	\$412
	36"	\$182	\$182	\$287	\$412
	38"	N/A	\$280	\$385	N/A

4-5/8" SYSTEMS (FA/KD)

		Height			
		78" Height	80" Height	84" Height	96" Height
	12"	\$313	\$313	\$561	N/A
	14"	\$313	\$313	\$561	N/A
	16"	\$313	\$313	\$561	N/A
	18"	\$313	\$313	\$561	\$686
	20"	\$321	\$321	\$569	\$694
	22"	\$321	\$321	\$569	\$694
	24"	\$321	\$321	\$569	\$694
	26"	\$326	\$326	\$574	\$699
	28"	\$326	\$326	\$574	\$699
	30"	\$326	\$326	\$574	\$699
	32"	\$339	\$339	\$587	\$712
	34"	\$349	\$349	\$597	\$722
	36"	\$349	\$349	\$597	\$722
	38"	N/A	\$447	\$695	N/A

DOORS

	Width	Height			
		78" Height	80" Height	84" Height	96" Height
1-3/8" PRO CORE	12"	\$371	\$296	\$401	N/A
	14"	\$371	\$296	\$401	N/A
	16"	\$371	\$296	\$401	N/A
	18"	\$371	\$296	\$401	\$526
	20"	\$379	\$304	\$409	\$534
	22"	\$379	\$304	\$409	\$534
	24"	\$379	\$304	\$409	\$534
	26"	\$384	\$309	\$414	\$539
	28"	\$384	\$309	\$414	\$539
	30"	\$384	\$309	\$414	\$539
	32"	\$397	\$322	\$427	\$552
	34"	\$407	\$332	\$437	\$562
	36"	\$407	\$332	\$437	\$562
	38"	N/A	\$430	\$535	N/A

4-5/8" SYSTEMS (FA/KD)

		Height			
		78" Height	80" Height	84" Height	96" Height
	12"	\$586	\$511	\$711	N/A
	14"	\$586	\$511	\$711	N/A
	16"	\$586	\$511	\$711	N/A
	18"	\$586	\$511	\$711	\$836
	20"	\$594	\$519	\$719	\$844
	22"	\$594	\$519	\$719	\$844
	24"	\$594	\$519	\$719	\$844
	26"	\$599	\$524	\$724	\$849
	28"	\$599	\$524	\$724	\$849
	30"	\$599	\$524	\$724	\$849
	32"	\$612	\$537	\$737	\$862
	34"	\$622	\$547	\$747	\$872
	36"	\$622	\$547	\$747	\$872
	38"	N/A	\$645	\$845	N/A

BI-FOLD DOORS

	Width	Height				
		77" Height	79" Height	83" Height	95" Height	
1-3/8" BI-FOLDS	18"	\$194	\$194	\$299	N/A	
	20"	\$194	\$194	\$299		
	22"	\$194	\$194	\$299		
	24"	\$194	\$194	\$299		
	26"	\$210	\$210	\$315		
	28"	\$210	\$210	\$315		
	30"	\$210	\$210	\$315		\$440
	32"	\$228	\$228	\$333		\$458
	34"	\$228	\$228	\$333		\$458
	36"	\$228	\$228	\$333		\$458

JAMB UPGRADES FOR SYSTEMS

Upgrade	78"	80"	84"	96"
6-5/8" Primed (FJ)	+95	+95	+100	+100
4-5/8" Clear Pine/ (Mahogany in 80"only)	+130	+130	+105	+105
6-5/8" Clear Pine	+235	+235	N/A	N/A
4-5/8" Oak	+165	+165	+145	+145
6-5/8" Oak	+445	+445	+450	+450

ADDERS & UPGRADES

Slab only machining for 3 hinges & lock	\$17
Off Standard	\$215
Off Standard System (75" and up)	\$225
Off Standard System (73-75")	\$275

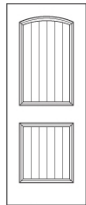

Santa-Fe



- **Slab: 2 Panel Smooth** (Ovolo Sticking)
- Fully Assembled/Knock Down Systems available (*Need handing*)

Shaded Blue Areas Denote Stock

DOORS

	Width	Height			
		78"	80"	84"	96"
1-3/8" HOLLOW CORE	12"	\$146	\$146	N/A	N/A
	14"	\$146	\$146	N/A	N/A
	16"	\$146	\$146	N/A	\$376
	18"	\$146	\$146	\$251	\$376
	20"	\$154	\$154	\$259	\$384
	22"	\$154	\$154	\$259	\$384
	24"	\$154	\$154	\$259	\$384
	26"	\$159	\$159	\$264	\$389
	28"	\$159	\$159	\$264	\$389
	30"	\$159	\$159	\$264	\$389
	32"	\$172	\$172	\$277	\$402
	34"	\$182	\$182	\$287	\$412
	36"	\$182	\$182	\$287	\$412

4-5/8" SYSTEMS (FA/KD)

		Height			
		78"	80"	84"	96"
	12"	\$313	\$313	N/A	N/A
	14"	\$313	\$313	N/A	N/A
	16"	\$313	\$313	N/A	\$686
	18"	\$313	\$313	\$561	\$686
	20"	\$321	\$321	\$569	\$694
	22"	\$321	\$321	\$569	\$694
	24"	\$321	\$321	\$569	\$694
	26"	\$326	\$326	\$574	\$699
	28"	\$326	\$326	\$574	\$699
	30"	\$326	\$326	\$574	\$699
	32"	\$339	\$339	\$587	\$712
	34"	\$349	\$349	\$597	\$722
	36"	\$349	\$349	\$597	\$722

DOORS

	Width	Height			
		78"	80"	84"	96"
1-3/8" PRO CORE	12"	\$371	\$296	N/A	N/A
	14"	\$371	\$296	N/A	N/A
	16"	\$371	\$296	N/A	\$526
	18"	\$371	\$296	\$401	\$526
	20"	\$379	\$304	\$409	\$534
	22"	\$379	\$304	\$409	\$534
	24"	\$379	\$304	\$409	\$534
	26"	\$384	\$309	\$414	\$539
	28"	\$384	\$309	\$414	\$539
	30"	\$384	\$309	\$414	\$539
	32"	\$397	\$322	\$427	\$552
	34"	\$407	\$332	\$437	\$562
	36"	\$407	\$332	\$437	\$562

4-5/8" SYSTEMS (FA/KD)

		Height			
		78"	80"	84"	96"
	12"	\$586	\$511	N/A	N/A
	14"	\$586	\$511	N/A	N/A
	16"	\$586	\$511	N/A	\$836
	18"	\$586	\$511	\$711	\$836
	20"	\$594	\$519	\$719	\$844
	22"	\$594	\$519	\$719	\$844
	24"	\$594	\$519	\$719	\$844
	26"	\$599	\$524	\$724	\$849
	28"	\$599	\$524	\$724	\$849
	30"	\$599	\$524	\$724	\$849
	32"	\$612	\$537	\$737	\$862
	34"	\$622	\$547	\$747	\$872
	36"	\$622	\$547	\$747	\$872

BI-FOLD DOORS

	Width	Height					
		77"	79"	83"	95"		
1-3/8" BI-FOLDS	18"	\$194	\$194	N/A	N/A		
	20"	\$194	\$194				
	22"	\$194	\$194				
	24"	\$194	\$194				
	26"	\$210	\$210				
	28"	\$210	\$210				
	30"	\$210	\$210			\$315	\$440
	32"	\$228	\$228			\$333	\$458
	34"	\$228	\$228			\$333	\$458
	36"	\$228	\$228			\$333	\$458

JAMB UPGRADES FOR SYSTEMS

System	+95	+95	+100	+100
6-5/8" Primed (FJ)				
4-5/8" Clear Pine/ (Mahogany in 80" only)	+130	+130	+105	+105
6-5/8" Clear Pine	+235	+235	N/A	N/A
4-5/8" Oak	+165	+165	+145	+145
6-5/8" Oak	+445	+445	+450	+450

ADDERS & UPGRADES

Slab only machining for 3 hinges & lock	\$17
Off Standard	\$215
Off Standard System (75" and up)	\$225
Off Standard System (73-75")	\$275



Rockport

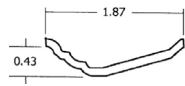

- **Slab: 5 Panel Smooth** (Cove & Bead Sticking)
- Fully Assembled/Knock Down Systems available (*Need handing*)
- 96" Doors are designed with 6 panels vs. 5

Shaded Blue Areas Denote Stock

DOORS

	Width	78" Height	80" Height	84" Height	96" Height
	1-3/8" HOLLOW CORE	12"	\$146	\$146	N/A
14"		\$146	\$146	N/A	N/A
16"		\$146	\$146	N/A	\$376
18"		\$146	\$146	\$251	\$376
20"		\$154	\$154	\$259	\$384
22"		\$154	\$154	\$259	\$384
24"		\$154	\$154	\$259	\$384
26"		\$159	\$159	\$264	\$389
28"		\$159	\$159	\$264	\$389
30"		\$159	\$159	\$264	\$389
32"		\$172	\$172	\$277	\$402
34"		\$182	\$182	\$287	\$412
36"		\$182	\$182	\$287	\$412

4-5/8" SYSTEMS (FA/KD)

	78" Height	80" Height	84" Height	96" Height
	\$313	\$313	N/A	N/A
	\$313	\$313	N/A	N/A
	\$313	\$313	N/A	\$686
	\$313	\$313	\$561	\$686
	\$321	\$321	\$569	\$694
	\$321	\$321	\$569	\$694
	\$321	\$321	\$569	\$694
	\$326	\$326	\$574	\$699
	\$326	\$326	\$574	\$699
	\$326	\$326	\$574	\$699
	\$326	\$326	\$574	\$699
	\$339	\$339	\$587	\$712
	\$349	\$349	\$597	\$722
	\$349	\$349	\$597	\$722

DOORS

	Width	78" Height	80" Height	84" Height	96" Height
	1-3/8" PRO CORE	12"	\$371	\$296	N/A
14"		\$371	\$296	N/A	N/A
16"		\$371	\$296	N/A	\$526
18"		\$371	\$296	\$401	\$526
20"		\$379	\$304	\$409	\$534
22"		\$379	\$304	\$409	\$534
24"		\$379	\$304	\$409	\$534
26"		\$384	\$309	\$414	\$539
28"		\$384	\$309	\$414	\$539
30"		\$384	\$309	\$414	\$539
32"		\$397	\$322	\$427	\$552
34"		\$407	\$332	\$437	\$562
36"		\$407	\$332	\$437	\$562

4-5/8" SYSTEMS (FA/KD)

	78" Height	80" Height	84" Height	96" Height
	\$586	\$511	N/A	N/A
	\$586	\$511	N/A	N/A
	\$586	\$511	N/A	\$836
	\$586	\$511	\$711	\$836
	\$594	\$519	\$719	\$844
	\$594	\$519	\$719	\$844
	\$594	\$519	\$719	\$844
	\$599	\$524	\$724	\$849
	\$599	\$524	\$724	\$849
	\$599	\$524	\$724	\$849
	\$612	\$537	\$737	\$862
	\$622	\$547	\$747	\$872
	\$622	\$547	\$747	\$872

BI-FOLD DOORS

	Width	77" Height	79" Height	83" Height	95" Height		
	1-3/8" BI-FOLDS	18"	\$194	\$194	N/A	N/A	
20"		\$194	\$194				
22"		\$194	\$194				
24"		\$194	\$194				
26"		\$210	\$210				
28"		\$210	\$210				
30"		\$210	\$210	\$315			\$440
32"		\$228	\$228	\$333			\$458
34"		\$228	\$228	\$333			\$458
36"		\$228	\$228	\$333			\$458

JAMB UPGRADES FOR SYSTEMS

6-5/8" Primed (FJ)	+95	+95	+100	+100
4-5/8" Clear Pine/ (Mahogany in 80"only)	+130	+130	+105	+105
6-5/8" Clear Pine	+235	+235	N/A	N/A
4-5/8" Oak	+165	+165	+145	+145
6-5/8" Oak	+445	+445	+450	+450

ADDERS & UPGRADES

Slab only machining for 3 hinges & lock	\$17
Off Standard	\$215
Off Standard System (75" and up)	\$225
Off Standard System (73-75")	\$275



Craftsman

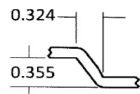

- **Slab: 3 Panel Smooth Flat Panel** (Craftsman Sticking)
- Fully Assembled/Knock Down Systems available (*Need handing*)

Shaded Blue Areas Denote Stock

DOORS

	Width	78" Height	80" Height	84" Height	96" Height
1-3/8" HOLLOW CORE	12"	\$186	\$186	\$291	N/A
	14"	\$186	\$186	\$291	
	16"	\$186	\$186	\$291	
	18"	\$186	\$186	\$291	
	20"	\$194	\$194	\$299	
	22"	\$194	\$194	\$299	
	24"	\$194	\$194	\$299	
	26"	\$199	\$199	\$304	
	28"	\$199	\$199	\$304	
	30"	\$199	\$199	\$304	
	32"	\$212	\$212	\$317	
	34"	\$222	\$222	\$327	
	36"	\$222	\$222	\$327	

4-5/8" SYSTEMS (FA/KD)

	78" Height	80" Height	84" Height	96" Height
	\$353	\$353	\$601	N/A
	\$353	\$353	\$601	
	\$353	\$353	\$601	
	\$353	\$353	\$601	
	\$361	\$361	\$609	
	\$361	\$361	\$609	
	\$361	\$361	\$609	
	\$366	\$366	\$614	
	\$366	\$366	\$614	
	\$366	\$366	\$614	
	\$379	\$379	\$627	
	\$389	\$389	\$637	
	\$389	\$389	\$637	

DOORS

	Width	78" Height	80" Height	84" Height	96" Height
1-3/8" PRO CORE	12"	\$411	\$336	\$441	N/A
	14"	\$411	\$336	\$441	
	16"	\$411	\$336	\$441	
	18"	\$411	\$336	\$441	
	20"	\$419	\$344	\$449	
	22"	\$419	\$344	\$449	
	24"	\$419	\$344	\$449	
	26"	\$424	\$349	\$454	
	28"	\$424	\$349	\$454	
	30"	\$424	\$349	\$454	
	32"	\$437	\$362	\$467	
	34"	\$447	\$372	\$477	
	36"	\$447	\$372	\$477	

4-5/8" SYSTEMS (FA/KD)

	78" Height	80" Height	84" Height	96" Height
	\$626	\$551	\$751	N/A
	\$626	\$551	\$751	
	\$626	\$551	\$751	
	\$626	\$551	\$751	
	\$634	\$559	\$759	
	\$634	\$559	\$759	
	\$634	\$559	\$759	
	\$639	\$564	\$764	
	\$639	\$564	\$764	
	\$639	\$564	\$764	
	\$652	\$577	\$777	
	\$662	\$587	\$787	
	\$662	\$587	\$787	

BI-FOLD DOORS

	Width	77" Height	79" Height	83" Height	95" Height
1-3/8" BI-FOLDS	18"	N/A			N/A
	20"	N/A			
	22"	\$234	\$234	\$339	
	24"	\$234	\$234	\$339	
	26"	\$250	\$250	\$355	
	28"	\$250	\$250	\$355	
	30"	\$250	\$250	\$355	
	32"	\$268	\$268	\$373	
	34"	\$268	\$268	\$373	
	36"	\$268	\$268	\$373	

JAMB UPGRADES FOR SYSTEMS

6-5/8" Primed (FJ)	+95	+95	+100	+100
4-5/8" Clear Pine/ (Mahogany in 80"only)	+130	+130	+105	+105
6-5/8" Clear Pine	+235	+235	N/A	N/A
4-5/8" Oak	+165	+165	+145	+145
6-5/8" Oak	+445	+445	+450	+450

ADDERS & UPGRADES

Slab only machining for 3 hinges & lock	\$17
Off Standard	\$215
Off Standard System (75" and up)	\$225
Off Standard System (73-75")	\$275

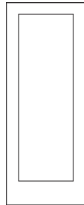

Madison

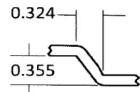

- **Slab: 1 Panel Smooth Flat Panel** (Craftsman Sticking)
- Fully Assembled/Knock Down Systems available (*Need handing*)

Shaded Blue Areas Denote Stock

DOORS

Width		78" Height	80" Height	84" Height	96" Height
1-3/8" HOLLOW CORE	12"	\$186	\$186	\$291	N/A
	14"	\$186	\$186	\$291	N/A
	16"	\$186	\$186	\$291	\$416
	18"	\$186	\$186	\$291	\$416
	20"	\$194	\$194	\$299	\$424
	22"	\$194	\$194	\$299	\$424
	24"	\$194	\$194	\$299	\$424
	26"	\$199	\$199	\$304	\$429
	28"	\$199	\$199	\$304	\$429
	30"	\$199	\$199	\$304	\$429
	32"	\$212	\$212	\$317	\$442
	34"	\$222	\$222	\$327	\$452
	36"	\$222	\$222	\$327	\$452

4-5/8" SYSTEMS (FA/KD)

78" Height	80" Height	84" Height	96" Height
\$353	\$353	\$601	N/A
\$353	\$353	\$601	N/A
\$353	\$353	\$601	\$726
\$353	\$353	\$601	\$726
\$361	\$361	\$609	\$734
\$361	\$361	\$609	\$734
\$361	\$361	\$609	\$734
\$366	\$366	\$614	\$739
\$366	\$366	\$614	\$739
\$366	\$366	\$614	\$739
\$379	\$379	\$627	\$752
\$389	\$389	\$637	\$762
\$389	\$389	\$637	\$762

DOORS

Width		78" Height	80" Height	84" Height	96" Height
1-3/8" PRO CORE	12"	\$411	\$336	\$441	N/A
	14"	\$411	\$336	\$441	N/A
	16"	\$411	\$336	\$441	\$566
	18"	\$411	\$336	\$441	\$566
	20"	\$419	\$344	\$449	\$574
	22"	\$419	\$344	\$449	\$574
	24"	\$419	\$344	\$449	\$574
	26"	\$424	\$349	\$454	\$579
	28"	\$424	\$349	\$454	\$579
	30"	\$424	\$349	\$454	\$579
	32"	\$437	\$362	\$467	\$592
	34"	\$447	\$372	\$477	\$602
	36"	\$447	\$372	\$477	\$602

4-5/8" SYSTEMS (FA/KD)

78" Height	80" Height	84" Height	96" Height
\$626	\$551	\$751	N/A
\$626	\$551	\$751	N/A
\$626	\$551	\$751	\$876
\$626	\$551	\$751	\$876
\$634	\$559	\$759	\$884
\$634	\$559	\$759	\$884
\$634	\$559	\$759	\$884
\$639	\$564	\$764	\$889
\$639	\$564	\$764	\$889
\$639	\$564	\$764	\$889
\$652	\$577	\$777	\$902
\$662	\$587	\$787	\$912
\$662	\$587	\$787	\$912

BI-FOLD DOORS

Width		77" Height	79" Height	83" Height	95" Height	
1-3/8" BI-FOLDS	18"	N/A			N/A	
	20"					
	22"	\$234	\$234	\$339		
	24"	\$234	\$234	\$339		
	26"	\$250	\$250	\$355		
	28"	\$250	\$250	\$355		
	30"	\$250	\$250	\$355		\$480
	32"	\$268	\$268	\$373		\$498
	34"	\$268	\$268	\$373		\$498
	36"	\$268	\$268	\$373		\$498

JAMB UPGRADES FOR SYSTEMS

6-5/8" Primed (FJ)	+95	+95	+100	+100
4-5/8" Clear Pine/ (Mahogany in 80"only)	+130	+130	+105	+105
6-5/8" Clear Pine	+235	+235	N/A	N/A
4-5/8" Oak	+165	+165	+145	+145
6-5/8" Oak	+445	+445	+450	+450

ADDERS & UPGRADES

Slab only machining for 3 hinges & lock	\$17
Off Standard	\$215
Off Standard System (75" and up)	\$225
Off Standard System (73-75")	\$275

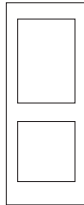

Monroe

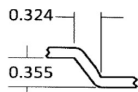

- **Slab: 2 Panel Smooth Flat Panel** (Craftsman Sticking)
- Fully Assembled/Knock Down Systems available (*Need handing*)

Shaded Blue Areas Denote Stock

DOORS

	Width	Height			
		78"	80"	84"	96"
1-3/8" HOLLOW CORE	12"	\$186	\$186	\$291	N/A
	14"	\$186	\$186	\$291	N/A
	16"	\$186	\$186	\$291	\$416
	18"	\$186	\$186	\$291	\$416
	20"	\$194	\$194	\$299	\$424
	22"	\$194	\$194	\$299	\$424
	24"	\$194	\$194	\$299	\$424
	26"	\$199	\$199	\$304	\$429
	28"	\$199	\$199	\$304	\$429
	30"	\$199	\$199	\$304	\$429
	32"	\$212	\$212	\$317	\$442
	34"	\$222	\$222	\$327	\$452
	36"	\$222	\$222	\$327	\$452

4-5/8" SYSTEMS (FA/KD)

		Height			
		78"	80"	84"	96"
1-3/8" HOLLOW CORE	12"	\$353	\$353	\$601	N/A
	14"	\$353	\$353	\$601	N/A
	16"	\$353	\$353	\$601	\$726
	18"	\$353	\$353	\$601	\$726
	20"	\$361	\$361	\$609	\$734
	22"	\$361	\$361	\$609	\$734
	24"	\$361	\$361	\$609	\$734
	26"	\$366	\$366	\$614	\$739
	28"	\$366	\$366	\$614	\$739
	30"	\$366	\$366	\$614	\$739
	32"	\$379	\$379	\$627	\$752
	34"	\$389	\$389	\$637	\$762
	36"	\$389	\$389	\$637	\$762

DOORS

	Width	Height			
		78"	80"	84"	96"
1-3/8" PRO CORE	12"	\$411	\$336	\$441	N/A
	14"	\$411	\$336	\$441	N/A
	16"	\$411	\$336	\$441	\$566
	18"	\$411	\$336	\$441	\$566
	20"	\$419	\$344	\$449	\$574
	22"	\$419	\$344	\$449	\$574
	24"	\$419	\$344	\$449	\$574
	26"	\$424	\$349	\$454	\$579
	28"	\$424	\$349	\$454	\$579
	30"	\$424	\$349	\$454	\$579
	32"	\$437	\$362	\$467	\$592
	34"	\$447	\$372	\$477	\$602
	36"	\$447	\$372	\$477	\$602

4-5/8" SYSTEMS (FA/KD)

		Height			
		78"	80"	84"	96"
1-3/8" PRO CORE	12"	\$626	\$551	\$751	N/A
	14"	\$626	\$551	\$751	N/A
	16"	\$626	\$551	\$751	\$876
	18"	\$626	\$551	\$751	\$876
	20"	\$634	\$559	\$759	\$884
	22"	\$634	\$559	\$759	\$884
	24"	\$634	\$559	\$759	\$884
	26"	\$639	\$564	\$764	\$889
	28"	\$639	\$564	\$764	\$889
	30"	\$639	\$564	\$764	\$889
	32"	\$652	\$577	\$777	\$902
	34"	\$662	\$587	\$787	\$912
	36"	\$662	\$587	\$787	\$912

BI-FOLD DOORS

	Width	Height			
		77"	79"	83"	95"
1-3/8" BI-FOLDS	18"	N/A			
	20"	N/A			
	22"	\$234	\$234	\$339	N/A
	24"	\$234	\$234	\$339	N/A
	26"	\$250	\$250	\$355	N/A
	28"	\$250	\$250	\$355	N/A
	30"	\$250	\$250	\$355	\$480
	32"	\$268	\$268	\$373	\$498
	34"	\$268	\$268	\$373	\$498
	36"	\$268	\$268	\$373	\$498

JAMB UPGRADES FOR SYSTEMS

System	+95	+95	+100	+100
6-5/8" Primed (FJ)				
4-5/8" Clear Pine/ (Mahogany in 80"only)	+130	+130	+105	+105
6-5/8" Clear Pine	+235	+235	N/A	N/A
4-5/8" Oak	+165	+165	+145	+145
6-5/8" Oak	+445	+445	+450	+450

ADDERS & UPGRADES

Slab only machining for 3 hinges & lock	\$17
Off Standard	\$215
Off Standard System (75" and up)	\$225
Off Standard System (73-75")	\$275

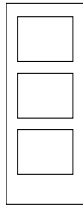

Birkdale

- **Slab: Craftsman Style** (Stile And Rail Construction)
- Fully Assembled/Knock Down Systems available (*Need handing*)

Shaded Blue Areas Denote Stock

DOORS

Width		78" Height	80" Height	84" Height	96" Height
1-3/8" HOLLOW CORE	12"	\$186	\$186	<u>N/A</u>	<u>N/A</u>
	14"	\$186	\$186	<u>N/A</u>	<u>N/A</u>
	16"	\$186	\$186	\$291	\$416
	18"	\$186	\$186	\$291	\$416
	20"	\$194	\$194	\$299	\$424
	22"	\$194	\$194	\$299	\$424
	24"	\$194	\$194	\$299	\$424
	26"	\$199	\$199	\$304	\$429
	28"	\$199	\$199	\$304	\$429
	30"	\$199	\$199	\$304	\$429
	32"	\$212	\$212	\$317	\$442
	34"	\$222	\$222	\$327	\$452
	36"	\$222	\$222	\$327	\$452

4-5/8" SYSTEMS (FA/KD)

78" Height	80" Height	84" Height	96" Height
\$353	\$353	<u>N/A</u>	<u>N/A</u>
\$353	\$353	<u>N/A</u>	<u>N/A</u>
\$353	\$353	\$601	\$726
\$353	\$353	\$601	\$726
\$361	\$361	\$609	\$734
\$361	\$361	\$609	\$734
\$361	\$361	\$609	\$734
\$366	\$366	\$614	\$739
\$366	\$366	\$614	\$739
\$366	\$366	\$614	\$739
\$366	\$366	\$614	\$739
\$379	\$379	\$627	\$752
\$389	\$389	\$637	\$762
\$389	\$389	\$637	\$762

DOORS

Width		78" Height	80" Height	84" Height*	96" Height*
1-3/8" PRO CORE	12"	\$411	\$336	<u>N/A</u>	<u>N/A</u>
	14"	\$411	\$336	<u>N/A</u>	<u>N/A</u>
	16"	\$411	\$336	\$441	\$566
	18"	\$411	\$336	\$441	\$566
	20"	\$419	\$344	\$449	\$574
	22"	\$419	\$344	\$449	\$574
	24"	\$419	\$344	\$449	\$574
	26"	\$424	\$349	\$454	\$579
	28"	\$424	\$349	\$454	\$579
	30"	\$424	\$349	\$454	\$579
	32"	\$437	\$362	\$467	\$592
	34"	\$447	\$372	\$477	\$602
	36"	\$447	\$372	\$477	\$602

4-5/8" SYSTEMS (FA/KD)

78" Height	80" Height	84" Height*	96" Height*
\$626	\$551	<u>N/A</u>	<u>N/A</u>
\$626	\$551	<u>N/A</u>	<u>N/A</u>
\$626	\$551	\$751	\$876
\$626	\$551	\$751	\$876
\$634	\$559	\$759	\$884
\$634	\$559	\$759	\$884
\$634	\$559	\$759	\$884
\$634	\$559	\$759	\$884
\$639	\$564	\$764	\$889
\$639	\$564	\$764	\$889
\$639	\$564	\$764	\$889
\$652	\$577	\$777	\$902
\$662	\$587	\$787	\$912
\$662	\$587	\$787	\$912

BI-FOLD DOORS

Width		77" Height	79" Height	83" Height	95" Height
1-3/8" BI-FOLDS	18"	<u>N/A</u>	<u>N/A</u>	<u>N/A</u>	<u>N/A</u>
	20"				
	22"				
	24"	\$234	\$234	\$339	
	26"	\$250	\$250	\$355	
	28"	\$250	\$250	\$355	
	30"	\$250	\$250	\$355	
	32"	\$268	\$268	\$373	
	34"	\$268	\$268	\$373	
	36"	\$268	\$268	\$373	

JAMB UPGRADES FOR SYSTEMS

6-5/8" Primed (FJ)	+95	+95	+100	+100
4-5/8" Clear Pine/ (Mahogany in 80"only)	+130	+130	+105	+105
6-5/8" Clear Pine	+235	+235	N/A	N/A
4-5/8" Oak	+165	+165	+145	+145
6-5/8" Oak	+445	+445	+450	+450

ADDERS & UPGRADES

Slab only machining for 3 hinges & lock	\$17
Off Standard	\$215
Off Standard System (75" and up)	\$225
Off Standard System (73-75")	\$275



Conmore

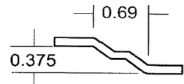

- **Slab: 5 Panel Smooth Flat Panel** (Flat Panel Sticking)
- Fully Assembled/Knock Down Systems available (*Need handing*)

Shaded Blue Areas Denote Stock

DOORS

	Width	78" Height	80" Height	84" Height	96" Height
	1-3/8" HOLLOW CORE	12"	\$176	\$176	\$281
14"		\$176	\$176	\$281	N/A
16"		\$176	\$176	\$281	\$406
18"		\$176	\$176	\$281	\$406
20"		\$184	\$184	\$289	\$414
22"		\$184	\$184	\$289	\$414
24"		\$184	\$184	\$289	\$414
26"		\$189	\$189	\$294	\$419
28"		\$189	\$189	\$294	\$419
30"		\$189	\$189	\$294	\$419
32"		\$202	\$202	\$307	\$432
34"		\$212	\$212	\$317	\$442
36"		\$212	\$212	\$317	\$442

4-5/8" SYSTEMS (FA/KD)

	78" Height	80" Height	84" Height	96" Height
	\$343	\$343	\$591	N/A
	\$343	\$343	\$591	N/A
	\$343	\$343	\$591	\$716
	\$343	\$343	\$591	\$716
	\$351	\$351	\$599	\$724
	\$351	\$351	\$599	\$724
	\$351	\$351	\$599	\$724
	\$356	\$356	\$604	\$729
	\$356	\$356	\$604	\$729
	\$356	\$356	\$604	\$729
	\$369	\$369	\$617	\$742
	\$379	\$379	\$627	\$752
	\$379	\$379	\$627	\$752

DOORS

	Width	78" Height	80" Height	84" Height	96" Height
	1-3/8" PRO CORE	12"	\$401	\$326	\$431
14"		\$401	\$326	\$431	N/A
16"		\$401	\$326	\$431	N/A
18"		\$401	\$326	\$431	N/A
20"		\$409	\$334	\$439	N/A
22"		\$409	\$334	\$439	N/A
24"		\$409	\$334	\$439	\$564
26"		\$414	\$339	\$444	\$569
28"		\$414	\$339	\$444	\$569
30"		\$414	\$339	\$444	\$569
32"		\$427	\$352	\$457	\$582
34"		\$437	\$362	\$467	\$592
36"		\$437	\$362	\$467	\$592

4-5/8" SYSTEMS (FA/KD)

	78" Height	80" Height	84" Height	96" Height
	\$616	\$541	\$741	N/A
	\$616	\$541	\$741	N/A
	\$616	\$541	\$741	N/A
	\$616	\$541	\$741	N/A
	\$624	\$549	\$749	N/A
	\$624	\$549	\$749	N/A
	\$624	\$549	\$749	\$874
	\$629	\$554	\$754	\$879
	\$629	\$554	\$754	\$879
	\$629	\$554	\$754	\$879
	\$642	\$567	\$767	\$892
	\$652	\$577	\$777	\$902
	\$652	\$577	\$777	\$902

BI-FOLD DOORS

	Width	77" Height	79" Height	83" Height	95" Height
	1-3/8" BI-FOLDS	18"	\$224	\$224	\$329
20"		\$224	\$224	\$329	
22"		\$224	\$224	\$329	
24"		\$224	\$224	\$329	
26"		\$240	\$240	\$345	
28"		\$240	\$240	\$345	
30"		\$240	\$240	\$345	
32"		\$258	\$258	\$363	
34"		\$258	\$258	\$363	
36"		\$258	\$258	\$363	

JAMB UPGRADES FOR SYSTEMS

6-5/8" Primed (FJ)	+95	+95	+100	+100
4-5/8" Clear Pine/ (Mahogany in 80"only)	+130	+130	+105	+105
6-5/8" Clear Pine	+235	+235	N/A	N/A
4-5/8" Oak	+165	+165	+145	+145
6-5/8" Oak	+445	+445	+450	+450

ADDERS & UPGRADES

Slab only machining for 3 hinges & lock	\$17
Off Standard	\$215
Off Standard System (75" and up)	\$225
Off Standard System (73-75")	\$275

Primed Hardboard

- **Slab: Primed Flush**
- Fully Assembled/Knock Down Systems available (*Need handing*)
- *Reversible Systems available in 78"/80" only **MARKED BY BOLD PRICING**

Shaded Blue Areas Denote Stock

DOORS

WIDTH	78" Height	80" Height	84" Height	96" Height
	12"	\$123	\$123	\$188
14"	\$123	\$123	\$188	\$303
16"	\$123	\$123	\$188	\$303
18"	\$123	\$123	\$188	\$303
20"	\$127	\$127	\$192	\$307
22"	\$127	\$127	\$192	\$307
24"	\$127	\$127	\$192	\$307
26"	\$135	\$135	\$200	\$315
28"	\$135	\$135	\$200	\$315
30"	\$135	\$135	\$200	\$315
32"	\$141	\$141	\$206	\$321
34"	\$153	\$153	\$218	\$333
36"	\$153	\$153	\$218	\$333
38"	\$246	\$246	\$311	\$426

4-5/8" SYSTEMS (FA/KD/RV*)

78" Height	80" Height	84" Height	96" Height
\$290	\$290	\$498	\$613
\$290	\$290	\$498	\$613
\$290	\$290	\$498	\$613
\$290	\$290	\$498	\$613
\$294	\$294	\$502	\$617
\$294	\$294	\$502	\$617
\$294	\$294	\$502	\$617
\$302	\$302	\$510	\$625
\$302	\$302	\$510	\$625
\$302	\$302	\$510	\$625
\$308	\$308	\$516	\$631
\$320	\$320	\$528	\$643
\$320	\$320	\$528	\$643
\$413	\$413	\$621	\$736

DOORS

Width	78" Height	80" Height	84" Height	96" Height
12"	\$303	\$263	\$303	\$443
14"	\$303	\$263	\$303	\$443
16"	\$303	\$263	\$303	\$443
18"	\$303	\$263	\$303	\$443
20"	\$307	\$267	\$307	\$447
22"	\$307	\$267	\$307	\$447
24"	\$307	\$267	\$307	\$447
26"	\$315	\$275	\$315	\$455
28"	\$315	\$275	\$315	\$455
30"	\$315	\$275	\$315	\$455
32"	\$321	\$281	\$321	\$461
34"	\$333	\$293	\$333	\$473
36"	\$333	\$293	\$333	\$473
38"	\$426	\$386	\$426	\$566

4-5/8" SYSTEMS (FA/KD)

78" Height	80" Height	84" Height	96" Height
\$518	\$478	\$613	\$753
\$518	\$478	\$613	\$753
\$518	\$478	\$613	\$753
\$518	\$478	\$613	\$753
\$522	\$482	\$617	\$757
\$522	\$482	\$617	\$757
\$522	\$482	\$617	\$757
\$530	\$490	\$625	\$765
\$530	\$490	\$625	\$765
\$530	\$490	\$625	\$765
\$536	\$496	\$631	\$771
\$548	\$508	\$643	\$783
\$548	\$508	\$643	\$783
\$641	\$601	\$736	\$876

BI-FOLD DOORS

Width	77" Height	79" Height	83" Height	95" Height
18"	\$168	\$168	\$233	\$348
20"	\$168	\$168	\$233	\$348
22"	\$168	\$168	\$233	\$348
24"	\$168	\$168	\$233	\$348
26"	\$185	\$185	\$250	\$365
28"	\$185	\$185	\$250	\$365
30"	\$185	\$185	\$250	\$365
32"	\$200	\$200	\$265	\$380
34"	\$200	\$200	\$265	\$380
36"	\$200	\$200	\$265	\$380

JAMB UPGRADES FOR SYSTEMS

6-5/8" Primed (FJ)	+95	+95	+100	+100
4-5/8" Clear Pine/ (Mahogany in 80"only)	+130	+130	+105	+105
6-5/8" Clear Pine	+235	+235	N/A	N/A
4-5/8" Oak	+165	+165	+145	+145
6-5/8" Oak	+445	+445	+450	+450

ADDERS & UPGRADES

Slab only machining for 3 hinges & lock	\$17
Off Standard	\$215
Off Standard System (75" and up)	\$225
Off Standard System (73-75")	\$275

Mahogany

- Slab: **Flush Mahogany** (unfinished)
- Fully Assembled/Knock Down Systems available (*Need handing*)

Shaded Blue Areas Denote Stock

DOORS

	Width	78" Height	80" Height	84" Height	96" Height
1-3/8" HOLLOW CORE	12"	\$175	\$175	\$270	\$425
	14"	\$175	\$175	\$270	\$425
	16"	\$175	\$175	\$270	\$425
	18"	\$175	\$175	\$270	\$425
	20"	\$179	\$179	\$274	\$429
	22"	\$179	\$179	\$274	\$429
	24"	\$179	\$179	\$274	\$429
	26"	\$188	\$188	\$283	\$438
	28"	\$188	\$188	\$283	\$438
	30"	\$198	\$198	\$293	\$448
	32"	\$203	\$203	\$298	\$453
	34"	\$223	\$223	\$318	\$473
	36"	\$223	\$223	\$318	\$473
38"	\$338	\$338	\$433	\$588	

4-5/8" SYSTEMS (FA/KD)

	78" Height	80" Height	84" Height	96" Height
	\$390	\$390	\$580	\$735
	\$390	\$390	\$580	\$735
	\$390	\$390	\$580	\$735
	\$390	\$390	\$580	\$735
	\$394	\$394	\$584	\$739
	\$394	\$394	\$584	\$739
	\$394	\$394	\$584	\$739
	\$403	\$403	\$593	\$748
	\$403	\$403	\$593	\$748
	\$413	\$413	\$603	\$758
	\$418	\$418	\$608	\$763
	\$438	\$438	\$628	\$783
	\$438	\$438	\$628	\$783
	\$553	\$553	\$743	\$898

DOORS

	Width	78" Height	80" Height	84" Height	96" Height
1-3/8" PRO CORE	12"	\$400	\$360	\$400	\$590
	14"	\$400	\$360	\$400	\$590
	16"	\$400	\$360	\$400	\$590
	18"	\$400	\$360	\$400	\$590
	20"	\$404	\$364	\$404	\$594
	22"	\$404	\$364	\$404	\$594
	24"	\$404	\$364	\$404	\$594
	26"	\$413	\$373	\$413	\$603
	28"	\$413	\$373	\$413	\$603
	30"	\$423	\$383	\$423	\$613
	32"	\$428	\$388	\$428	\$618
	34"	\$448	\$408	\$448	\$638
	36"	\$448	\$408	\$448	\$638
38"	\$563	\$523	\$563	\$753	

4-5/8" SYSTEMS (FA/KD)

	78" Height	80" Height	84" Height	96" Height
	\$615	\$575	\$710	\$900
	\$615	\$575	\$710	\$900
	\$615	\$575	\$710	\$900
	\$615	\$575	\$710	\$900
	\$619	\$579	\$714	\$904
	\$619	\$579	\$714	\$904
	\$619	\$579	\$714	\$904
	\$628	\$588	\$723	\$913
	\$628	\$588	\$723	\$913
	\$638	\$598	\$733	\$923
	\$643	\$603	\$738	\$928
	\$663	\$623	\$758	\$948
	\$663	\$623	\$758	\$948
	\$778	\$738	\$873	\$1,063

BI-FOLD DOORS

	Width	77" Height	79" Height	83" Height	95" Height
1-3/8" BI-FOLDS	18"	\$284	\$284	\$379	\$534
	20"	\$284	\$284	\$379	\$534
	22"	\$284	\$284	\$379	\$534
	24"	\$284	\$284	\$379	\$534
	26"	\$316	\$316	\$411	\$566
	28"	\$316	\$316	\$411	\$566
	30"	\$316	\$316	\$411	\$566
	32"	\$341	\$341	\$436	\$591
	34"	\$341	\$341	\$436	\$591
	36"	\$341	\$341	\$436	\$591

JAMB UPGRADES FOR SYSTEMS

6-5/8" Primed (FJ)	+95	+95	+100	+100
4-5/8" Clear Pine/ (Mahogany in 80"only)	+130	+130	+105	+105
6-5/8" Clear Pine	+235	+235	N/A	N/A
4-5/8" Oak	+165	+165	+145	+145
6-5/8" Oak	+445	+445	+450	+450

ADDERS & UPGRADES

Slab only machining for 3 hinges & lock	\$17
Off Standard	\$215
Off Standard System (75" and up)	\$225
Off Standard System (73-75")	\$275



• Solid Particle Door

*NOTE: OFF STD - Applies to over 1" below the listed heights or widths

MOULDED

WIDTH	80" Height	82 / 84" Height	96" Height
12"	\$510	\$560	\$780
14"	\$510	\$560	\$780
16"	\$510	\$560	\$780
18"	\$510	\$560	\$780
20"	\$520	\$570	\$790
22"	\$520	\$570	\$790
24"	\$520	\$570	\$790
26"	\$528	\$578	\$798
28"	\$528	\$578	\$798
30"	\$528	\$578	\$798
32"	\$535	\$585	\$805
34"	\$547	\$597	\$817
36"	\$547	\$597	\$817
38" (CARRARA Only)	\$635	\$685	\$905
ADDERS			
Off Standard*	\$215	\$215	\$215
Conmore	\$20	\$20	N/A
Craftsman / Madison / Monroe / Birkdale	\$40	\$40	\$40
Executive Moulding	\$510	\$510	\$510
Deadbolt or Peephole	\$16	\$16	\$16
Machining	\$65	\$65	\$65

PRIMED HARDBOARD

WIDTH	80" Height	82 / 84" Height	96" Height
12"	\$295	\$355	\$535
14"	\$295	\$355	\$535
16"	\$295	\$355	\$535
18"	\$295	\$355	\$535
20"	\$300	\$360	\$540
22"	\$300	\$360	\$540
24"	\$300	\$360	\$540
26"	\$310	\$370	\$550
28"	\$310	\$370	\$550
30"	\$310	\$370	\$550
32"	\$315	\$375	\$555
34"	\$330	\$390	\$570
36"	\$330	\$390	\$570
38"	\$410	\$470	\$650
ADDERS			
Off Standard*	\$215	\$215	\$215
Deadbolt or Peephole	\$16	\$16	\$16
Machining	\$65	\$65	\$65

MAHOGANY

WIDTH	80" Height	82 / 84" Height	96" Height
12"	\$388	\$488	\$668
14"	\$388	\$488	\$668
16"	\$388	\$488	\$668
18"	\$388	\$488	\$668
20"	\$388	\$488	\$668
22"	\$388	\$488	\$668
24"	\$388	\$488	\$668
26"	\$400	\$500	\$680
28"	\$400	\$500	\$680
30"	\$406	\$506	\$686
32"	\$418	\$518	\$698
34"	\$430	\$530	\$710
36"	\$430	\$530	\$710
38"	\$552	\$652	\$832
ADDERS			
Off Standard*	\$215	\$215	\$215
Deadbolt or Peephole	\$16	\$16	\$16
Machining	\$65	\$65	\$65

1-3/4" 20min. Fire Rated Doors



20
MIN
FIRE RATED

- Machined for 3 hinges and cylinder lock
- Machining sheet required (See Page 60)
- **45 min. Rating does not apply to Craftsman, Madison, Monroe, Birkdale and Conmore Doors*

**NOTE: OFF STD - Applies to over 1" below the listed heights or widths*

MOULDED

WIDTH	80" Height	82 / 84" Height	96" Height
12"	\$595	\$645	\$865
14"	\$595	\$645	\$865
16"	\$595	\$645	\$865
18"	\$595	\$645	\$865
20"	\$605	\$655	\$875
22"	\$605	\$655	\$875
24"	\$605	\$655	\$875
26"	\$613	\$663	\$883
28"	\$613	\$663	\$883
30"	\$613	\$663	\$883
32"	\$620	\$670	\$890
34"	\$632	\$682	\$902
36"	\$632	\$682	\$902
38" (CARRARA Only)	\$720	\$770	\$990
ADDERS			
Off Standard*	\$215	\$215	\$215
Conmore	\$20	\$20	N/A
Craftsman / Madison / Monroe / Birkdale	\$40	\$40	\$40
45 Min. Rating*	\$1,355	\$1,355	\$1,355
Deadbolt or Peephole	\$16	\$16	\$16

PRIMED HARDBOARD

WIDTH	80" Height	82 / 84" Height	96" Height
12"	\$380	\$440	\$620
14"	\$380	\$440	\$620
16"	\$380	\$440	\$620
18"	\$380	\$440	\$620
20"	\$385	\$445	\$625
22"	\$385	\$445	\$625
24"	\$385	\$445	\$625
26"	\$395	\$455	\$635
28"	\$395	\$455	\$635
30"	\$395	\$455	\$635
32"	\$400	\$460	\$640
34"	\$415	\$475	\$655
36"	\$415	\$475	\$655
38"	\$495	\$555	\$735
ADDERS			
Off Standard*	\$215	\$215	\$215
Deadbolt or Peephole	\$16	\$16	\$16
45 Min. Rating	\$845	\$845	\$845
60 / 90 Min. Rating	\$1,235	\$1,235	\$1,235



20
MIN
FIRE RATED

20min. Fire Rated Door System



Prehung Fire Rated Doors in Fire Rated Wood Jambs

- 4-9/16" Fully Assembled Door system in LH or RH
- Can be paired with 20min 1-3/4" Moulded or Primed Hardboard doors in 80" Height or less
- Fire labels applied to Door and Jamb
- Doors come with 4" Self Closing/bearing Satin Nickel hinges or Matt Black hinges for Fire code
- White Weather-strip for air seal



Solid Particleboard Core



20 MIN Fire Rating
Available for 1-3/4" Doors

20MIN FIRE RATED JAMB UPGRADES SYSTEM ADDERS

	78"	80"
4 9/16" Primed Finger Joint (Standard)	+\$350	+\$350

Hollow Metal Doors

Daybar Steel Doors and Frames

1-3/4" Fire-Rated Daybar Steel Doors

- 90 min. Fire Rated Label
- Machined for 3 hinges and cylinder lock
- Undersized (fits Daybar frame)
- 20 Ga. Steel

Shaded Blue Areas Denote Stock

80" (79-1/8") DOORS

SKU	SIZE	PRICE
DA-D0C266-MD0004	29-3/4"x79-1/8"	\$860
DA-D0C286-MD0004	31-3/4"x79-1/8"	\$860
DA-D0C216-MD0004	33-3/4"x79-1/8"	\$860
DA-D0C306-MD0004	35-3/4"x79-1/8"	\$860

84" (83-1/8") SPECIAL ORDER DOORS

DA-D0C217L-MD0004	2'10"x7'0" LH	\$860
DA-D0C217R-MD0004	2'10"x7'0" RH	\$860
DA-D0C307L-MD0004	3'0"x7'0" LH	\$860
DA-D0C307R-MD0004	3'0"x7'0" RH	\$860

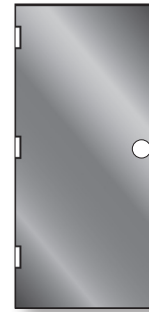

EXPANDABLE DAYBAR HOLLOW METAL FRAMES (90 MIN. FIRE EMBOSSED)

- Throat adjusts to different wall depths from 5-3/8" to 8-11/16" deep
- 3pc frame for 13/4" door slabs (order header, hinge & strike jambs)
- 4-12" x 4" hinge prep & 4-7/8" strike prep
- Use with Steel or Wood studs

**NOTE: Must price hinges, headers & jambs for complete system*

HINGES

SKU	DESCRIPTION	PACK	SIZE	PRICE PER PACK
ON-4823NBB	Full mortise Butt Hinges	3	4-1/2" x 4"	\$50
ON-5823NBB1	Adjustable Spring Hinge	1	4-1/2" x 4"	\$30



DAYBAR HEADERS

SKU	SIZE	PRICE
DA-EF226	30"	\$170
DA-EF228	32"	\$170
DA-EF221	34"	\$170
DA-EF230	36"	\$170
DA-EF232	38"	\$220

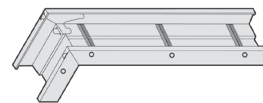

DAYBAR JAMBS

SKU	SYSTEM	PRICE
80" SIZE		
DA-EF2H6L (Hinge)	Left Hand	\$380
DA-EF2S6L (Strike)		\$305
DA-EF2H6R (Hinge)	Right Hand	\$380
DA-EF2S6R (Strike)		\$305

84" SIZE		
DA-EF2H7L (Hinge)	Left Hand	\$380
DA-EF2S7L (Strike)		\$305
DA-EF2H7R (Hinge)	Right Hand	\$380
DA-EF2S7R (Strike)		\$305

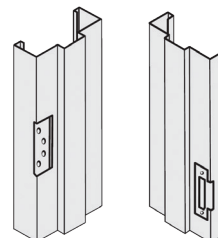

Pocket Door & Hardware

Pocket Door Frame & Hardware Sets

- Durable design offers a quiet and smooth motion
- Slide-in nesting feature makes installation easy
- Holds doors weighing up to 150 lbs (68 kg)
- For opening sizes up to 36" (91.4 cm)
- Jump-proof design keeps doors in track

Shaded Blue Areas Denote Stock

POCKET DOOR FRAME SET

SKU	DESCRIPTION	SKID QTY	PRICE
ON-148150BC	36" x 80" Pocket Door Kit	64	\$240.00
ON-1488150BC	36" x 96" Pocket Door Kit		\$350.00

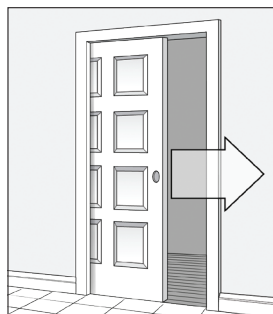

POCKET DOOR KIT WITH SOFT CLOSE

SKU	DESCRIPTION	PRICE
ON-89YM3680SC	36" x 80" Pocket Door Kit w/Soft Close	\$490.00
ON-89YM3696SC	36" x 96" Pocket Door Kit w/Soft Close	\$500.00
ON-89YM4896SC	48" x 96" Pocket Door Kit w/Soft Close	\$525.00



- Tracks and frames can be cut to door width and height
- Ball bearing wheels
- Suitable for 1-3/8 in (35 mm) or 1-3/4 in (45 mm) thick doors weighing up to 220lbs (100kg)
- Includes door edge finger pull to allow for full retraction into the pocket area

BI-FOLD TOP TRACKS

SKU	DESCRIPTION	SIZE	PRICE
DC-000071	Bi-fold Top Track	18"	\$13.00
DC-006482	Bi-fold Top Track	24"	\$14.00
DC-006483	Bi-fold Top Track	30"	\$18.00
DC-006484	Bi-fold Top Track	32"	\$18.00
DC-006485	Bi-fold Top Track	36"	\$19.00
DC-006348	Bi-fold Top Track	48"	\$28.00
DC-006349	Bi-fold Top Track	60"	\$35.00
DC-006350	Bi-fold Top Track	72"	\$37.00
DC-018624	Bi-fold Top Track	96"	\$50.00
DC-006351	Bi-fold Hardware Bag for Track		\$31.00
DC-000524	Pivot Door Hardware		\$43.00

SLIDING DOOR BY-PASS HARDWARE SET

- For two sliding doors 3/4" to 1-3/8" (1.9 cm to 3.5 cm) thick weighing up to 60 lbs (27.2 kg) each
- Dial-adjust door hangers
- Durable rollers offer a quiet and smooth motion
- Sturdy floor guide resists hard shocks
- Jump-proof V-shaped steel track

SKU	OPENING SIZE	SKID QTY	PRICE	SKID PRICE
ON-14648BC	48"	10	\$43.50	\$40.50
ON-14660BC	60"	6	\$45.00	\$41.50
ON-14672BC	72"	6	\$47.50	\$44.00
ON-14696BC	96"	2	\$55.00	\$51.00



Dome Bypass Closet Door Kit

Ball Bearing Closet Door Hardware

For sliding doors weighing up to 150 lbs each. Doors are top hung and run on a double aluminum track with integrated fascia suitable for door thicknesses of 1-3/8 to 1-3/4 in.

- Includes hardware for 2 sliding wood doors
- Ball bearing wheels for greater durability and longevity
- Includes two ring pulls that match the finish of the track
- Simple, flexible and low-cost installation



SKU	DESCRIPTION	PRICE
ON-89XC48B90	Dome Bypass Closet Door Kit Black 48"	\$220.00
ON-89XC48W	Dome Bypass Closet Door Kit White 48"	\$220.00
ON-89XC60B90	Dome Bypass Closet Door Kit Black 60"	\$245.00
ON-89XC60W	Dome Bypass Closet Door Kit White 60"	\$245.00
ON-89XC72B90	Dome Bypass Closet Door Kit Black 72"	\$275.00
ON-89XC72W	Dome Bypass Closet Door Kit White 72"	\$275.00
ON-89XC96B90	Dome Bypass Closet Door Kit Black 96"	\$300.00
ON-89XC96W	Dome Bypass Closet Door Kit White 96"	\$300.00

Barn Door Hardware

Barn Door Hardware

- Made of steel
- Includes all necessary track and hardware
- Mounting hardware for concrete applications included
- For single door with a thickness of 1 3/8" or 1 3/4"
- Maximum weight up to 220lbs
- High density plastic wheels provide ultra-quiet operation
- Ideal for openings up to 36"W; wider than 36" require multiple tracks
- Hardware enables door to slide parallel to wall
- Anti-jump discs prevent hanger wheels from jumping off the track
- 2 types of floor guides included – concealed & wall mountable

Shaded Blue Areas Denote Stock

BENT STRAP

SKU	DESCRIPTION	PRICE
TL-BARN-BS-70-MB	Bent Strap Matte Black 78-3/4W"	\$352
TL-BARN-BS-80-MB	Bent Strap Matte Black 96"	\$407
TL-BARN-BS-70-SS	Bent Strap Stainless Steel 78-3/4W"	\$472
TL-BARN-BS-80-SS	Bent Strap Stainless Steel 96"	\$559

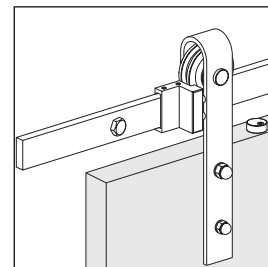

TOP OF DOOR STRAP

SKU	DESCRIPTION	PRICE
TL-BARN-TM-70-MB	Top Strap Matt Black 78-3/4W"	\$338
TL-BARN-TM-80-MB	Top Strap Matte Black 96"	\$425
TL-BARN-TM-70-SS	Top Strap Stainless Steel 78-3/4W"	\$462
TL-BARN-TM-80-SS	Top Strap Stainless Steel 96"	\$545

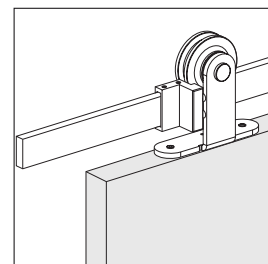

BYPASS WALL BRACKETS

5 needed per 7/0 kit, 6 needed per 8/0 kit

SKU	DESCRIPTION	PRICE
TL-BDBPBMB	Bypass Bracket Matte Black	\$60
TL-BDBPBSS	Bypass Bracket Stainless Steel	\$74



SOFT CLOSE

SKU	DESCRIPTION	PRICE
TL-BDFTSCMB	Soft Close Bracket Matte Black	\$215
TL-BDFTSCSS	Soft Close Bracket Stainless Steel	\$215

BIFOLD BARN DOOR KITS

SKU	DESCRIPTION	PRICE
ON-246TY707L13090	Bifold Barn Door Kit Matte Black 51" (1 Bifold)	\$275
ON-246TY707L16090	Bifold Barn Door Kit Matte Black 63" (2 Bifolds)	\$460
ON-246TY707L19090	Bifold Barn Door Kit Matte Black 75" (2 Bifolds)	\$475
ON-89TYL70790	Hardware Set Only (For Additional Bifold)	\$160



- Flexible installation with an upper pivot roller that can be fixed and locked as an anchor point at multiple positions
- No bottom guide tracks required for individual door panels up to 500 mm wide each
- Two surface-mount folding hinges
- Vertical rubber profile for door edge where two sets of bifold doors meet
- Matching pull handles for easy operation

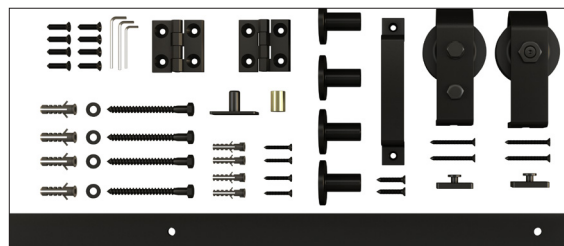

Barn Doors

1-3/8" Barn Doors

All Models are quick ship in 2 weeks

Z STYLE

- Factory Guide Groove Included
- 1/2" panels and 3/8" vertical grooves

SIZE	PRIMED	KNOTTY ALDER
36" x 84"	\$840	\$1,029
42" x 84"	\$892	\$1,098
48" x 84"	\$952	\$1,192
42" x 96"	\$960	\$1,218



K STYLE

- Factory Guide Groove Included
- 1/2" panels and 3/8" vertical grooves

SIZE	PRIMED	KNOTTY ALDER
36" x 84"	\$952	\$1,080
42" x 84"	\$1,020	\$1,166
48" x 84"	\$1,080	\$1,260
42" x 96"	\$1,115	\$1,303



FRENCH DOORS



Upgrade Slabs to a System



Fully Assembled (4 5/8") FA

- Prehung - ready to install
- Door and jambs machined for left or right handing
- Hinges are 3-1/2" Radius
- All single doors styles available (double doors not available)



Knock Down (4 5/8") KD

- Shipped knock down inside shrink wrapped packaging
- Door and jambs machined for left or right handing
- Hinges are 3-1/2" Radius
- All single and double doors available

NOTE: FRENCH DOORS MACHINED OR PREHUNG REQUIRE MACHINING SHEET FILLED OUT FOR CORRECT HANDING OF DECORATIVE GLASS.

System Upgrade Pricing / Pick your frame & add it to the cost of your door Slab

JAMB UPGRADES	BASE SYSTEM ADDERS				BIFOLD JAMB UPGRADES	BASE SYSTEM ADDERS			
	78"	80"	84"	96"		78"	80"	84"	96"
4 5/8" Primed Finger Joint (Standard)	+\$215	+\$215	+\$310	+\$310	4 5/8" Primed Finger Joint (Standard)	+\$175	+\$175	+\$260	+\$260
6 5/8" Primed (FJ)	+\$310	+\$310	+\$410	+\$410	6 5/8" Primed (FJ)	+\$260	+\$260	+\$360	+\$360
4 5/8" Clear Pine (Mahogany in 80" only)	+\$345	+\$345	+\$415	+\$415	4 5/8" Clear Pine (Mahogany in 80" only)	+\$295	+\$295	+\$365	+\$365
6 5/8" Clear Pine	+\$450	+\$450	N/A	N/A	6 5/8" Clear Pine	+\$400	+\$400	N/A	N/A
4 5/8" Oak	+\$380	+\$380	+\$455	+\$455	4 5/8" Oak	+\$330	+\$330	+\$405	+\$405
6 5/8" Oak	+\$660	+\$660	+\$760	+\$760	6 5/8" Oak	+\$610	+\$610	+\$710	+\$710
Double Doors	Standard with Ball Catch Matching Hinge Colour				FULL DOOR SYSTEM X 2				
Double Doors	Flush Bolt Upgrade				+\$20	+\$20	+\$20	+\$20	

Machining Upcharges

1-3/8" Doors Machining	3 Hinges & Lock	\$17
1-3/4" Doors Machining	3 Hinges & Lock	\$65

Hinge Colours Available

Satin Nickel / Brass / Antique Nickel / Antique Brass / Brushed Chrome / Venetian Bronze / White / Black

FRENCH DOORS

Wood Divider Reference

Ovolo vs Shaker

Ovolo : Models beginning with **3**
example : **303H**

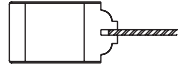

Shaker : Models beginning with **8**
example : **803H**



Dividers and Rail Types

Model # ending in M or O : Regular Wood Divider

Examples :
Ovolo 1/2" : #303M
#315O

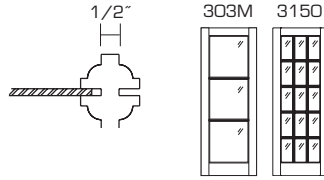

Shaker : N/A

L : Mini Rail

Example :
Ovolo 1-5/8" : #303L

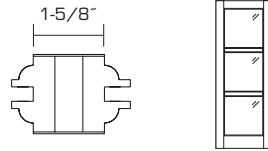

Example :
Shaker 2-3/8" : #803L

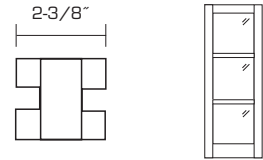

H : Regular Rail

Example :
Ovolo 3-13/16" : #303H

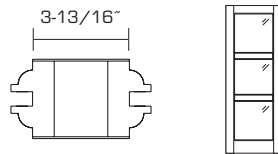

Example :
Shaker 4-11/32" : #803H

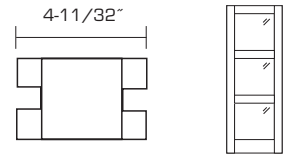

Panel Types

5/8" raised panel

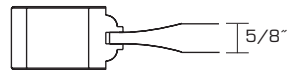

Regular Panel. Standard thickness of panel used for French Doors with a bottom panel.

3/8" flat panel

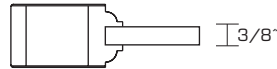

Available on request at same price as regular 5/8" panel.

Glass

Ovolo and Shaker

Glass is plastic wrapped for easy finishing.
Patterned glass : Only one side has pattern or texture, the opposite is clear and smooth.

Shaker Only

Glass can only be replaced by the manufacturer.
Bevelled glass is not available in Shaker series.

French Interior Door Profile Reference

OVOLO MOULDING

MODEL 3050

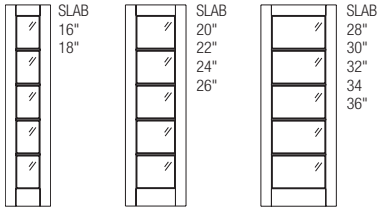

MODEL 3100

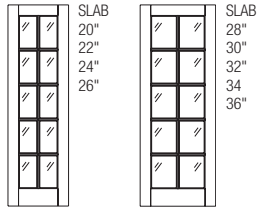

MODEL 3150

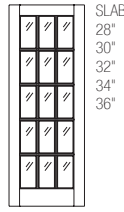

MODEL 303H

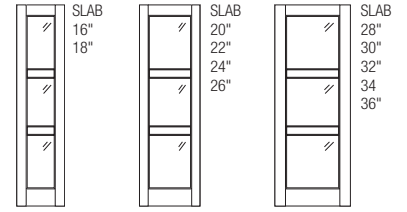

MODEL 1000

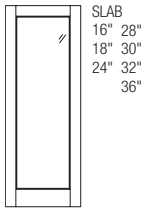

MODEL 304H

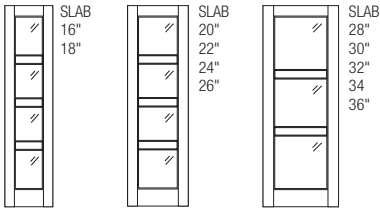

MODEL 305H

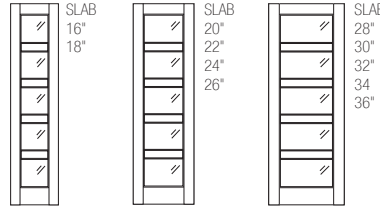

SHAKER MOULDING

MODEL 803H

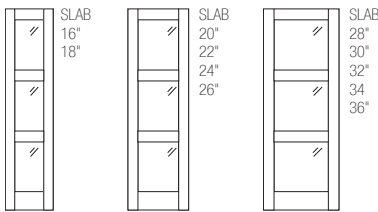

MODEL 804H

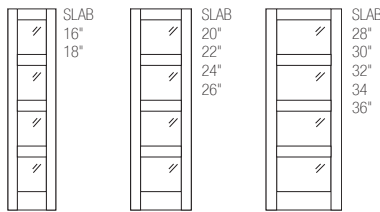

MODEL 805H



MODEL 6000

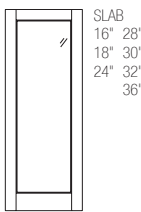

French Doors with Wood Divider -Ovolo

*Special Order French is available Online and through **Doorsmith DIGITAL**
COMPLETE DOOR QUOTING SOFTWARE

Shaded Blue Areas Denote Stock

80"H DOORS -PRIMED MDF

	Width	Clear Glass	White Satin
3050	16" / 18"	\$573	\$673
	20" / 22"	\$573	\$673
	24" / 26"	\$573	\$673
	28" / 30"	\$583	\$683
	32"	\$583	\$683
	34" / 36"	\$597	\$693

	Width	Clear Glass	White Satin
3100	20" / 22"	\$617	\$673
	24"	\$617	\$673
	26"	\$617	\$673
	28" / 30"	\$617	\$683
	32"	\$617	\$683
	34" / 36"	\$627	\$693

	Width	Clear Glass	White Satin
3150	28"	\$617	\$683
	30"	\$617	\$683
	32"	\$617	\$683
	34"	\$627	\$693
	36"	\$627	\$693

80"H DOORS -PRIMED MDF

	Width	Clear Glass	White Satin	Morocco
303H / 304H	16" / 18"	\$573	\$683	\$628
	20" / 22"	\$573	\$686	\$630
	24" / 26"	\$583	\$686	\$630
	28" / 30"	\$583	\$698	\$640
	32"	\$583	\$698	\$640
	34" / 36"	\$597	\$709	\$652

	Width	Clear Glass	White Satin	Morocco
305H	16" / 18"	\$573	\$683	\$628
	20" / 22"	\$573	\$686	\$630
	24" / 26"	\$583	\$686	\$630
	28" / 30"	\$583	\$698	\$640
	32"	\$583	\$698	\$640
	34" / 36"	\$597	\$709	\$652

80"H DOORS -PRIMED MDF

	Width	Clear Tempered	White Satin Tempered	Laminated White
1000	24"	\$533	\$677	\$677
	28" / 30"	\$550	\$683	\$683
	32"	\$550	\$683	\$683
	36"	\$570	\$700	\$700

French Doors with Wood Divider -Shaker

*Special Order French is available Online and through **Doorsmith DIGITAL**
COMPLETE DOOR QUOTING SOFTWARE

Shaded Blue Areas Denote Stock

80"H DOORS -PRIMED MDF

	Width	Clear Glass	White Satin	Morocco
803H	16" / 18"	\$573	\$683	\$628
	20" / 22"	\$573	\$686	\$630
	24" / 26"	\$573	\$686	\$630
	28"	\$583	\$698	\$640
	30"	\$583	\$698	\$640
	32"	\$583	\$698	\$640
	34" / 36"	\$597	\$709	\$652

	Width	Clear Glass	White Satin	Morocco
804H / 805H	16" / 18"	\$573	\$683	\$628
	20" / 22"	\$573	\$686	\$630
	24" / 26"	\$573	\$686	\$630
	28"	\$583	\$698	\$640
	30"	\$583	\$698	\$640
	32"	\$583	\$698	\$640
	34" / 36"	\$597	\$709	\$652

80"H DOORS -PRIMED MDF

	Width	Clear Tempered	White Satin Tempered	Laminated White
6000	24"	\$533	\$677	\$677
	28"	\$550	\$683	\$683
	30"	\$550	\$683	\$683
	32"	\$550	\$683	\$683
	36"	\$570	\$700	\$700

SHAKER DOORS



Upgrade Slabs to a System



Fully Assembled (4 5/8") FA

- Prehung - ready to install
- Door and jambs machined for left or right handing
- Hinges are 3-1/2" Radius
- All single doors styles available (double doors not available)



Knock Down (4 5/8") KD

- Shipped knock down inside shrink wrapped packaging
- Door and jambs machined for left or right handing
- Hinges are 3-1/2" Radius
- All single and double doors available

System Upgrade Pricing / Pick your frame & add it to the cost of your door Slab

JAMB UPGRADES	BASE SYSTEM ADDERS				BIFOLD JAMB UPGRADES	BASE SYSTEM ADDERS			
	78"	80"	84"	96"		78"	80"	84"	96"
4 5/8" Primed Finger Joint (Standard)	+\$215	+\$215	+\$310	+\$310	4 5/8" Primed Finger Joint (Standard)	+\$175	+\$175	+\$260	+\$260
6 5/8" Primed (FJ)	+\$310	+\$310	+\$410	+\$410	6 5/8" Primed (FJ)	+\$260	+\$260	+\$360	+\$360
4 5/8" Clear Pine (Mahogany in 80" only)	+\$345	+\$345	+\$415	+\$415	4 5/8" Clear Pine (Mahogany in 80" only)	+\$295	+\$295	+\$365	+\$365
6 5/8" Clear Pine	+\$450	+\$450	N/A	N/A	6 5/8" Clear Pine	+\$400	+\$400	N/A	N/A
4 5/8" Oak	+\$380	+\$380	+\$455	+\$455	4 5/8" Oak	+\$330	+\$330	+\$405	+\$405
6 5/8" Oak	+\$660	+\$660	+\$760	+\$760	6 5/8" Oak	+\$610	+\$610	+\$710	+\$710
Double Doors	Standard with Ball Catch Matching Hinge Colour				FULL DOOR SYSTEM X 2				
Double Doors	Flush Bolt Upgrade				+\$20	+\$20	+\$20	+\$20	

Machining Upcharges

1-3/8" Doors Machining	3 Hinges & Lock	\$17
1-3/4" Doors Machining	3 Hinges & Lock	\$65

Hinge Colours Available

Satin Nickel / Brass / Antique Nickel / Antique Brass / Brushed Chrome / Venetian Bronze / White / Black

Shaker Interior Door Profile Reference

FLAT PANEL MOULDING

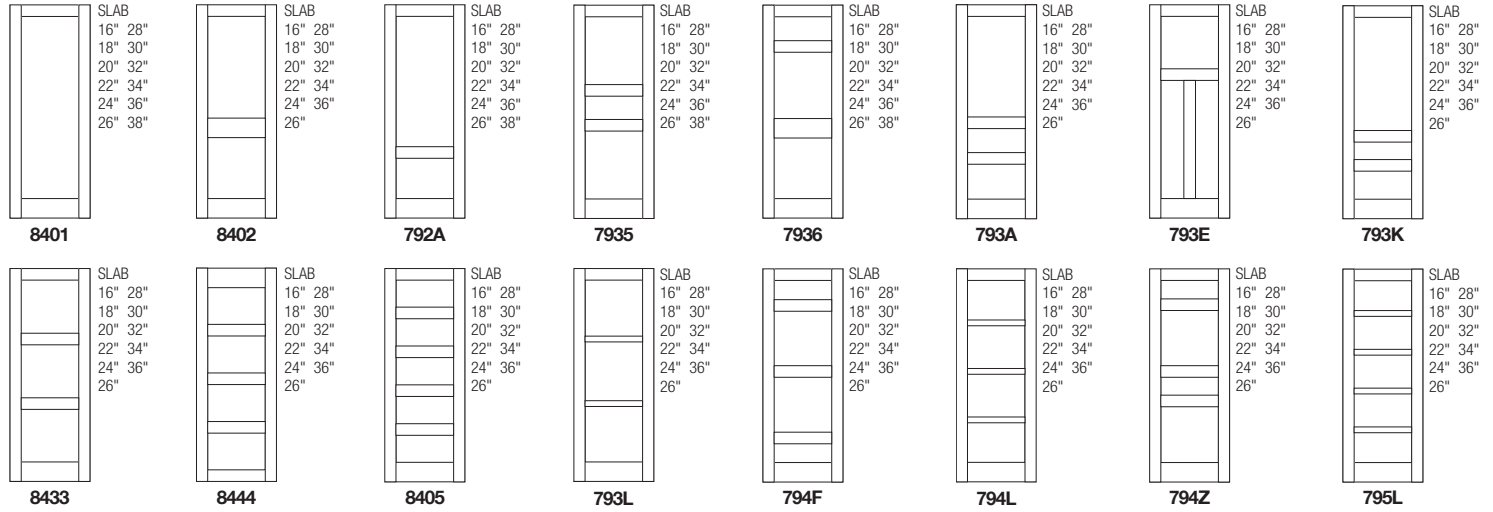

RAISED PANEL MOULDING

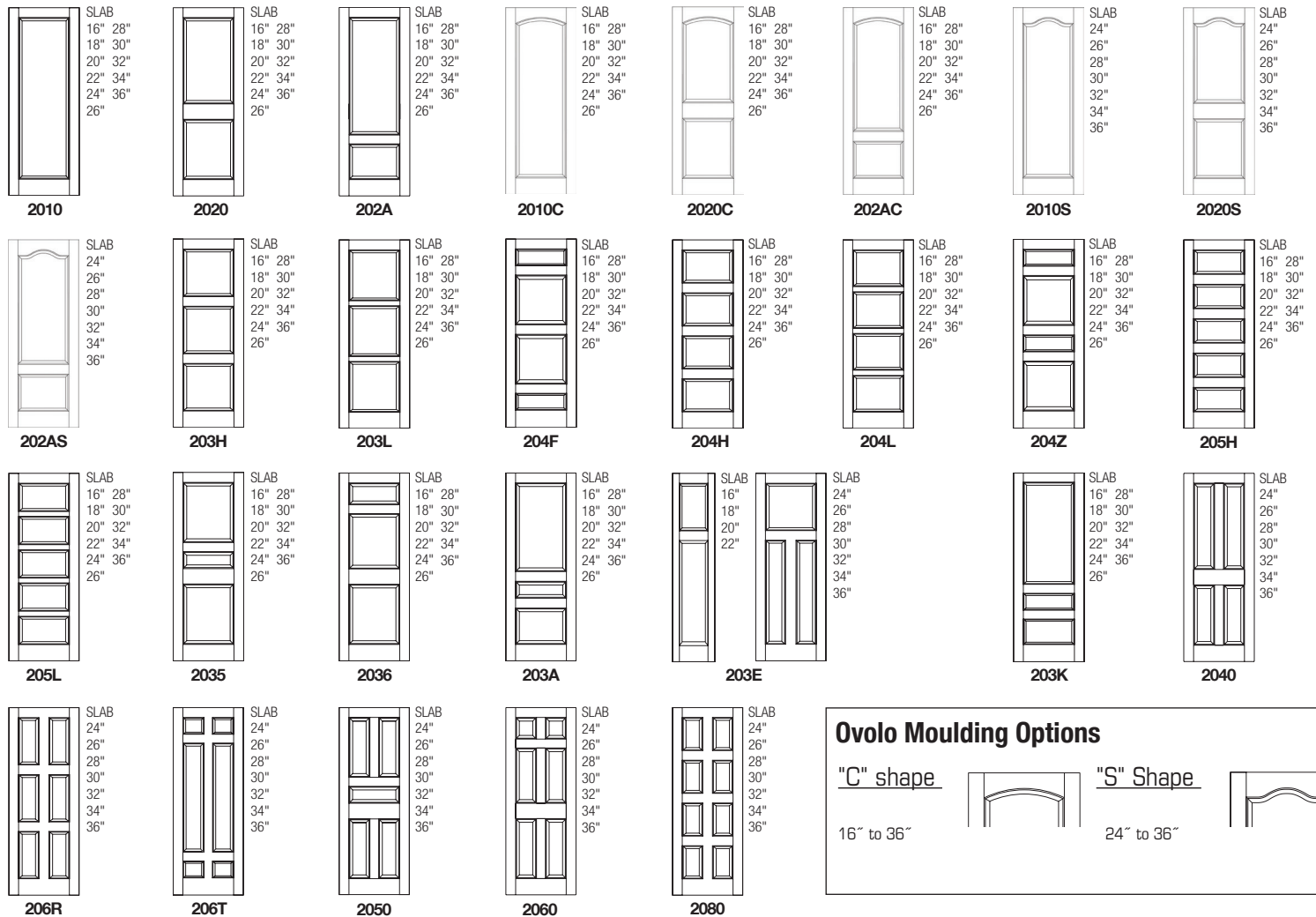

Shaker Doors

Primed White Shaker Doors

*Special Order Shaker is available Online and through **Doorsmith** DIGITAL COMPLETE DOOR QUOTING SOFTWARE

Shaded Blue Areas Denote Stock

80"H DOORS -PRIMED MDF

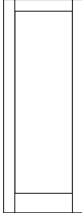

WIDTH		Primed White
8401	16"	\$295
	18"	\$295
	20"	\$295
	22"	\$320
	24"/26"	\$320
	28" / 30" / 32"	\$345
	34" / 36"	\$370
	38"	\$555

80"H DOORS -PRIMED MDF



WIDTH		Primed White
792A	16" / 18"	\$440
	20" / 22" / 24" / 26"	\$447
	28" / 30" / 32"	\$467
	34" / 36"	\$490
	38"	\$557

80"H DOORS -PRIMED MDF

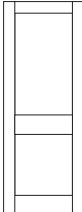

WIDTH		Primed White
8402	16" / 18" / 20"	\$320
	22"	\$345
	24"	\$345
	26"	\$345
	28" / 30" / 32"	\$370
	34"	\$395
	36"	\$395

80"H DOORS -PRIMED MDF



WIDTH		Primed White
8433	16"	\$320
	18"	\$320
	20"	\$320
	22"	\$345
	24"	\$345
	26"	\$345
	28" / 30" / 32"	\$370
	34" / 36"	\$395

80"H DOORS -PRIMED MDF

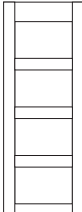

WIDTH		Primed White
8444	16" / 18" / 20"	\$345
	22"	\$370
	24"	\$370
	26"	\$370
	28" / 30" / 32"	\$395
	34"	\$420
	36"	\$420

80"H DOORS -PRIMED MDF



WIDTH		Primed White
8405	16"	\$345
	18"	\$345
	20"	\$345
	22"	\$370
	24"	\$370
	26"	\$370
	28" / 30" / 32"	\$395
	34" / 36"	\$420

80"H DOORS -PRIMED MDF

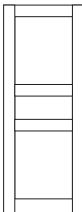

WIDTH		Primed White
7935	16" / 18"	\$442
	20" / 22" / 24" / 26"	\$447
	28" / 30" / 32"	\$467
	34" / 36"	\$498
	38"	\$583

80"H DOORS -PRIMED MDF

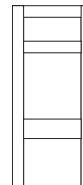

WIDTH		Primed White
7936	16" / 18"	\$442
	20" / 22" / 24" / 26"	\$447
	28" / 30" / 32"	\$467
	34" / 36"	\$498
	38"	\$583

Shaker Doors

Primed White Shaker Doors

*Special Order Shaker is available Online and through **Doorsmith** DIGITAL
COMPLETE DOOR QUOTING SOFTWARE

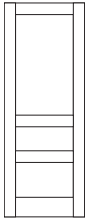

80"H DOORS -PRIMED MDF

WIDTH		Primed White
793A	16" / 18"	\$442
	20" / 22" / 24" / 26"	\$447
	28" / 30" / 32"	\$467
	34" / 36"	\$498
	38"	\$583

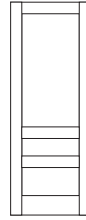

80"H DOORS -PRIMED MDF

WIDTH		Primed White
793K	16" / 18"	\$442
	20" / 22" / 24" / 26"	\$447
	28" / 30" / 32"	\$467
	34" / 36"	\$498
	38"	\$583

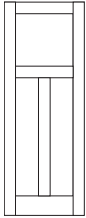

80"H DOORS -PRIMED MDF

WIDTH		Primed White
793E	16" / 18"	\$442
	20" / 22" / 24" / 26"	\$447
	28" / 30" / 32"	\$467
	34" / 36"	\$498
	38"	\$583

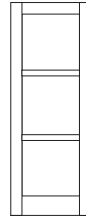

80"H DOORS -PRIMED MDF

WIDTH		Primed White
793L	16" / 18"	\$440
	20" / 22" / 24" / 26"	\$460
	28" / 30" / 32"	\$472
	34" / 36"	\$510
	38"	\$583

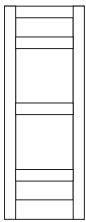

80"H DOORS -PRIMED MDF

WIDTH		Primed White
794F	16" / 18"	\$440
	20" / 22" / 24" / 26"	\$460
	28" / 30" / 32"	\$472
	34" / 36"	\$510
	38"	\$583

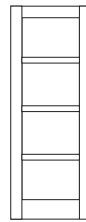

80"H DOORS -PRIMED MDF

WIDTH		Primed White
794L	16" / 18"	\$440
	20" / 22" / 24" / 26"	\$460
	28" / 30" / 32"	\$472
	34" / 36"	\$510
	38"	\$583

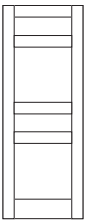

80"H DOORS -PRIMED MDF

WIDTH		Primed White
794Z	16" / 18"	\$440
	20" / 22" / 24" / 26"	\$460
	28" / 30" / 32"	\$472
	34" / 36"	\$510
	38"	\$583

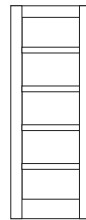

80"H DOORS -PRIMED MDF

WIDTH		Primed White
795L	16" / 18"	\$440
	20" / 22" / 24" / 26"	\$460
	28" / 30" / 32"	\$472
	34" / 36"	\$510
	38"	\$583

Raised Panel Doors

Raised Panel Shaker Doors

*Special Order Raised Panel is available Online and through **Doorsmith** DIGITAL COMPLETE DOOR QUOTING SOFTWARE

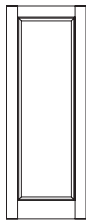

80"H DOORS -PRIMED MDF

WIDTH		Primed White
2010	16" / 18"	\$462
	20" / 22" / 24" / 26"	\$469
	28" / 30" / 32"	\$496
	34" / 36"	\$523
	38"	\$600

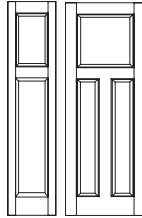

80"H DOORS -PRIMED MDF

WIDTH		Primed White
203E	16" / 18"	\$486
	20" / 22" / 24" / 26"	\$493
	28" / 30" / 32"	\$522
	34" / 36"	\$550
	38"	\$627

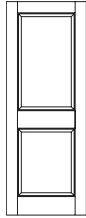

80"H DOORS -PRIMED MDF

WIDTH		Primed White
2020	16" / 18"	\$462
	20" / 22" / 24" / 26"	\$469
	28" / 30" / 32"	\$496
	34" / 36"	\$523
	38"	\$600

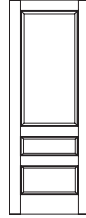

80"H DOORS -PRIMED MDF

WIDTH		Primed White
203K	16" / 18"	\$486
	20" / 22" / 24" / 26"	\$493
	28" / 30" / 32"	\$522
	34" / 36"	\$550
	38"	\$627

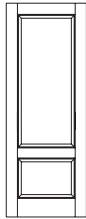

80"H DOORS -PRIMED MDF

WIDTH		Primed White
202A	16" / 18"	\$462
	20" / 22" / 24" / 26"	\$469
	28" / 30" / 32"	\$496
	34" / 36"	\$523
	38"	\$600

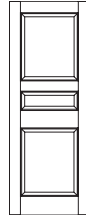

80"H DOORS -PRIMED MDF

WIDTH		Primed White
2035	16" / 18"	\$486
	20" / 22" / 24" / 26"	\$493
	28" / 30" / 32"	\$522
	34" / 36"	\$550
	38"	\$627

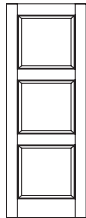

80"H DOORS -PRIMED MDF

WIDTH		Primed White
203H	16" / 18"	\$475
	20" / 22" / 24" / 26"	\$483
	28" / 30" / 32"	\$511
	34" / 36"	\$540
	38"	\$617

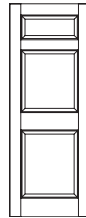

80"H DOORS -PRIMED MDF

WIDTH		Primed White
2036	16" / 18"	\$486
	20" / 22" / 24" / 26"	\$493
	28" / 30" / 32"	\$522
	34" / 36"	\$550
	38"	\$627

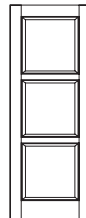

80"H DOORS -PRIMED MDF

WIDTH		Primed White
203L	16" / 18"	\$475
	20" / 22" / 24" / 26"	\$483
	28" / 30" / 32"	\$511
	34" / 36"	\$540
	38"	\$617

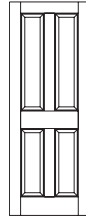

80"H DOORS -PRIMED MDF

WIDTH		Primed White
2040	16" / 18"	\$486
	20" / 22" / 24" / 26"	\$493
	28" / 30" / 32"	\$522
	34" / 36"	\$550
	38"	\$627

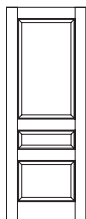

80"H DOORS -PRIMED MDF

WIDTH		Primed White
203A	16" / 18"	\$486
	20" / 22" / 24" / 26"	\$493
	28" / 30" / 32"	\$522
	34" / 36"	\$550
	38"	\$627

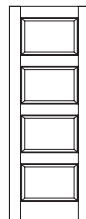

80"H DOORS -PRIMED MDF

WIDTH		Primed White
204H	16" / 18"	\$475
	20" / 22" / 24" / 26"	\$483
	28" / 30" / 32"	\$511
	34" / 36"	\$540
	38"	\$617

Raised Panel Doors

Raised Panel Shaker Doors

*Special Order Raised Panel is available Online and through **Doorsmith** DIGITAL COMPLETE DOOR QUOTING SOFTWARE

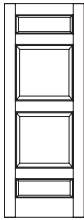

80"H DOORS -PRIMED MDF		
	WIDTH	Primed White
204F	16" / 18"	\$475
	20" / 22" / 24" / 26"	\$483
	28" / 30" / 32"	\$511
	34" / 36"	\$540
	38"	\$617

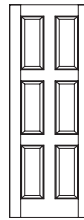

80"H DOORS -PRIMED MDF		
	WIDTH	Primed White
206R	24" / 26"	\$509
	28"	\$537
	30" / 32"	\$537
	34" / 36"	\$568
	38"	\$650

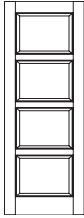

80"H DOORS -PRIMED MDF		
	WIDTH	Primed White
204L	16" / 18"	\$475
	20" / 22" / 24" / 26"	\$483
	28" / 30" / 32"	\$511
	34" / 36"	\$540
	38"	\$617

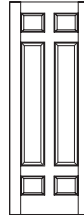

80"H DOORS -PRIMED MDF		
	WIDTH	Primed White
206T	24" / 26"	\$509
	28"	\$537
	30" / 32"	\$537
	34" / 36"	\$568
	38"	\$650

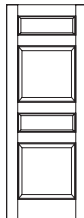

80"H DOORS -PRIMED MDF		
	WIDTH	Primed White
204Z	16" / 18"	\$475
	20" / 22" / 24" / 26"	\$483
	28" / 30" / 32"	\$511
	34" / 36"	\$540
	38"	\$617

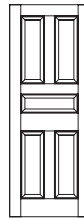

80"H DOORS -PRIMED MDF		
	WIDTH	Primed White
2050	24" / 26"	\$509
	28"	\$537
	30" / 32"	\$537
	34" / 36"	\$568
	38"	\$650

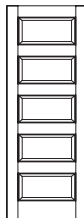

80"H DOORS -PRIMED MDF		
	WIDTH	Primed White
205H	16" / 18"	\$475
	20" / 22" / 24" / 26"	\$483
	28" / 30" / 32"	\$511
	34" / 36"	\$540
	38"	\$617

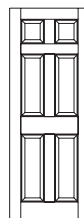

80"H DOORS -PRIMED MDF		
	WIDTH	Primed White
2060	24" / 26"	\$509
	28"	\$537
	30" / 32"	\$537
	34" / 36"	\$568
	38"	\$650

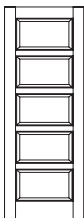

80"H DOORS -PRIMED MDF		
	WIDTH	Primed White
205L	16" / 18"	\$475
	20" / 22" / 24" / 26"	\$483
	28" / 30" / 32"	\$511
	34" / 36"	\$540
	38"	\$617

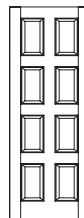

80"H DOORS -PRIMED MDF		
	WIDTH	Primed White
2080	24" / 26"	\$509
	28"	\$537
	30" / 32"	\$537
	34" / 36"	\$568
	38"	\$650

Special Order & Custom Sizes

Special Order French is available Online and through **Doorsmith** DIGITAL
COMPLETE DOOR QUOTING SOFTWARE

SHAKER PANEL

*SHOWN IN CLEAR PINE. ALSO AVAILABLE IN KNOTTY PINE & PRIMED MDF



SOLID WOOD

*SHOWN IN OAK



FRENCH GLASS OPTIONS

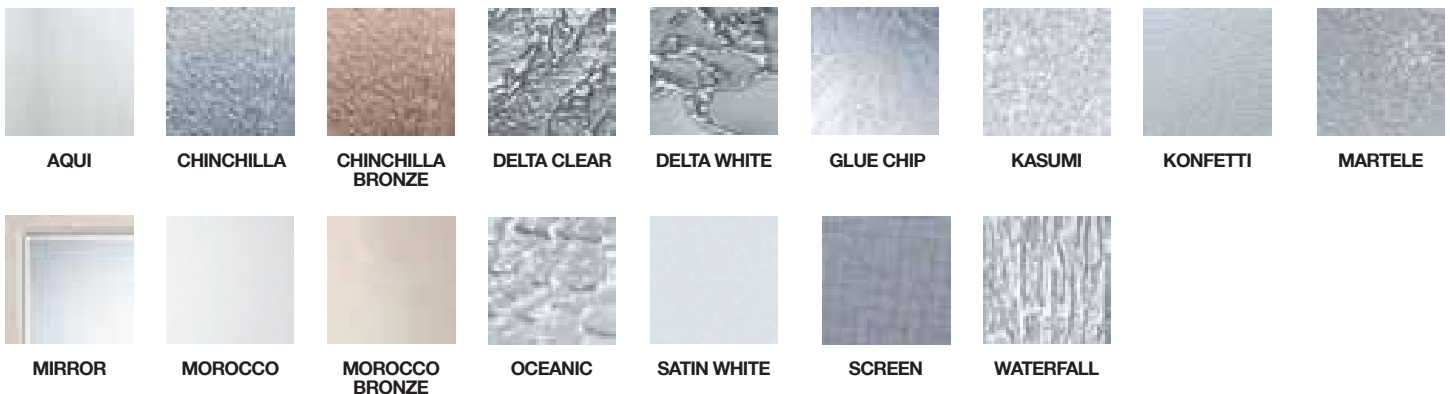

Special Order & Custom Sizes

Special Order French is available Online and through **Doorsmith** DIGITAL
COMPLETE DOOR QUOTING SOFTWARE

ONE-LITE DOORS



Model #1000 / Ovolo Raised Panel
Model #6000 / Flat Panel Shaker

Additional Glass Options



Satin White



Lami White

MULTI-LITE DOORS



1050



1100



1150

Available in Chrome,
Flat Silver, Gold or
Pewter Grilles

Additional Glass Options



Satin White



Clear Bevel

SHAKER FRENCH DOORS

*SHOWN IN CLEAR PINE



803H



804H



805H



6910



691A

SOLID WOOD DOORS

*SHOWN IN OAK



3030



3030C



3030S



3040



3040C



3040S



3050



3050C



3050S



3060



3060C



3060S



3080



3080C



3080S



3120



3120C



3120S



3150



3150C



3150S



3100



3100C



3100S



3090



3090C



3090S

QUICKSHIP French Interior Door Profile Reference

SHAKER PANEL

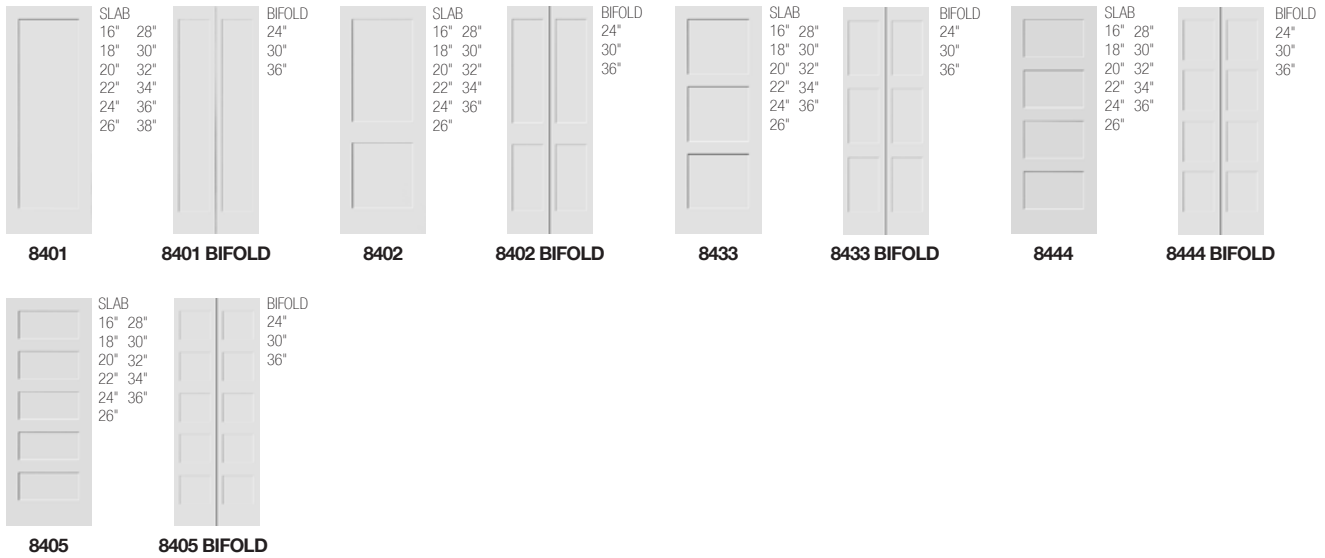

SHAKER FRENCH - Diffused White Laminate / DWL



SHAKER FRENCH - Clear

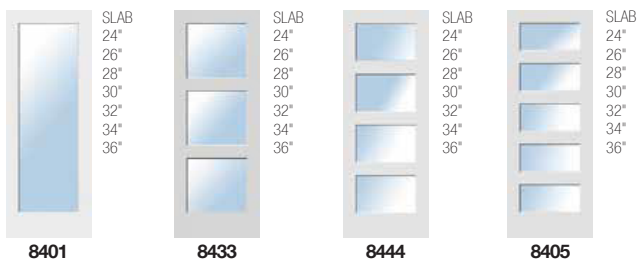

LOUVER

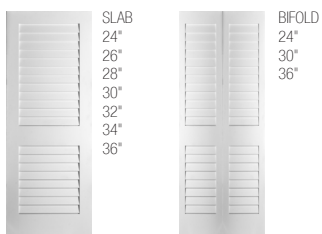

QUICKSHIP PROGRAM

Upgrade Slabs to a System



Fully Assembled (4⁵/₈") FA

- Prehung - ready to install
- Door and jambs machined for left or right handing
- Hinges are 3-1/2" Radius
- All single doors styles available (double doors not available)



Knock Down (4⁵/₈") KD

- Shipped knock down inside shrink wrapped packaging
- Door and jambs machined for left or right handing
- Hinges are 3-1/2" Radius
- All single and double doors available

System Upgrade Pricing / Pick your frame & add it to the cost of your door Slab

JAMB UPGRADES	BASE SYSTEM ADDERS				BIFOLD JAMB UPGRADES	BASE SYSTEM ADDERS			
	78"	80"	84"	96"		78"	80"	84"	96"
4 ⁵ / ₈ " Primed Finger Joint (Standard)	+\$215	+\$215	+\$310	+\$310	4 ⁵ / ₈ " Primed Finger Joint (Standard)	+\$175	+\$175	+\$260	+\$260
6 ⁵ / ₈ " Primed (FJ)	+\$310	+\$310	+\$410	+\$410	6 ⁵ / ₈ " Primed (FJ)	+\$260	+\$260	+\$360	+\$360
4 ⁵ / ₈ " Clear Pine (Mahogany in 80" only)	+\$345	+\$345	+\$415	+\$415	4 ⁵ / ₈ " Clear Pine (Mahogany in 80" only)	+\$295	+\$295	+\$365	+\$365
6 ⁵ / ₈ " Clear Pine	+\$450	+\$450	N/A	N/A	6 ⁵ / ₈ " Clear Pine	+\$400	+\$400	N/A	N/A
4 ⁵ / ₈ " Oak	+\$380	+\$380	+\$455	+\$455	4 ⁵ / ₈ " Oak	+\$330	+\$330	+\$405	+\$405
6 ⁵ / ₈ " Oak	+\$660	+\$660	+\$760	+\$760	6 ⁵ / ₈ " Oak	+\$610	+\$610	+\$710	+\$710
Double Doors	Standard with Ball Catch Matching Hinge Colour				FULL DOOR SYSTEM X 2				
Double Doors	Flush Bolt Upgrade				+\$20	+\$20	+\$20	+\$20	

Hinge Colours Available

Satin Nickel / Brass / Antique Nickel / Antique Brass / Brushed Chrome / Venetian Bronze / White / Black

Quickship French Doors

Primed Shaker Doors

*All models are Quickship 2 weeks

1-3/8" PRIMED SHAKER

80" DOORS

WIDTH	8401	8402	8433	8444	8405
16" / 18" / 20"	\$265	\$290	\$290	\$310	\$310
22" / 24" / 26"	\$290	\$315	\$315	\$330	\$330
28" / 30" / 32"	\$305	\$335	\$335	\$345	\$345
34" / 36"	\$335	\$360	\$360	\$375	\$375
38"	\$500	N/A			

84" DOORS

WIDTH	8401	8402	8433	8444	8405
18"	\$400	\$425	\$425	\$450	\$450
24" / 26"	\$420	\$465	\$465	\$495	\$495
28" / 30" / 32"	\$465	\$480	\$480	\$520	\$520
34" / 36"	\$500	\$510	\$510	\$550	\$550

96" DOORS

WIDTH	8401	8402	8433	8444	8405
18"	\$445	\$460	\$460	\$480	\$480
24" / 26"	\$560	\$503	\$503	\$530	\$530
28" / 30" / 32"	\$500	\$525	\$525	\$550	\$550
34" / 36"	\$525	\$545	\$545	\$575	\$575
38"	\$700	N/A			

79" BIFOLD

WIDTH	8401	8402	8433	8444	8405
24"	\$735	\$765	\$765	\$790	\$790
30"	\$790	\$820	\$820	\$845	\$845
36"	\$840	\$875	\$875	\$900	\$900

1-3/4" PRIMED SHAKER

80" DOORS

WIDTH	8401	8402	8433	8444
18"	\$456	\$481	\$505	\$530
20"	\$456	\$481	\$505	\$530
22"	\$481	\$505	\$530	\$554
24" / 26"	\$481	\$505	\$530	\$554
28" / 30"	\$505	\$530	\$554	\$579
32"	\$505	\$530	\$554	\$579
34" / 36"	\$530	\$554	\$579	\$603
38"	\$690	N/A		
ADDERS				
84" Size	\$25	\$25	\$25	\$25
90" Size	\$50	\$50	\$50	\$50
96" Size	\$75	\$75	\$75	\$75

20" and 22" not available in, 84", 90", or 96" heights

OPTIONAL BEADING TO SHAKER DOORS

All Models with Optional Beading applied are 3-4 weeks
Add upcharges listed below to above door options

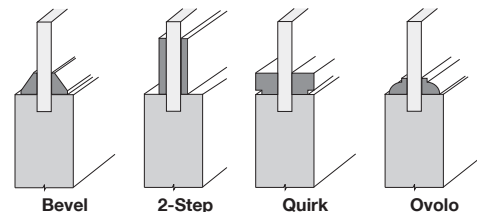

1-3/8 OR 1-3/4 DOORS

	8401	8402	8433	8444	8405
B0-Ovolo	+\$85	+\$165	+\$190	+\$265	+\$310
BS-Square	+\$160	+\$230	+\$255	+\$280	+\$320
B1-Quirk	+\$85	+\$165	+\$190	+\$265	+\$310
BB-Bevel	+\$85	+\$165	+\$190	+\$265	+\$310
8491 2 Step	+\$180	N/A			

1-3/8 BIFOLDS

	8401	8402	8433	8444	8405
B0-Ovolo	+\$170	+\$330	+\$380	+\$530	+\$620
BS-Square	+\$320	+\$460	+\$510	+\$560	+\$640
B1-Quirk	+\$170	+\$330	+\$380	+\$530	+\$620
BB-Bevel	+\$170	+\$330	+\$380	+\$530	+\$620
8491 2 Step	+\$360	N/A			

Quickship French Doors

Primed Shaker Doors

*All models are Quickship 2 weeks

1-3/8" PRIMED SHAKER FRENCH DOORS

DIFFUSED WHITE LAMINATE (80")

WIDTH	8401	8433	8444	8405
24"	\$505	\$530	\$590	\$590
26"	\$505	\$530	\$590	\$590
28"	\$540	\$575	\$645	\$645
30"	\$540	\$575	\$645	\$645
32"	\$540	\$575	\$645	\$645
34"	\$690	\$610	\$695	\$695
36"	\$690	\$610	\$695	\$695

CLEAR GLASS (80")

8401	8433	8444	8405
\$425	\$465	\$525	\$525
\$425	\$465	\$580	\$580
\$475	\$530	\$580	\$580
\$475	\$530	\$580	\$580
\$475	\$530	\$580	\$580
\$500	\$545	\$620	\$620
\$500	\$545	\$620	\$620

1-3/8" LOUVER DOORS

Trimlite's Primed Louver door increases ventilation and promotes air flow between rooms while providing the strength and stability of true stile and rail construction.

*All models are Quickship 2 weeks

- Bifolds include Rack & Hardware
- 3-1/4" Louver Slat Size

80" DOORS

WIDTH	1-3/8" PLANTATION LOUVER
24"	\$582
26"	\$582
28"	\$609
30"	\$609
32"	\$609
34"	\$638
36"	\$638

79" BIFOLD

1-3/8" PLANTATION LOUVER
\$978
N/A
\$1,019
N/A
\$1,062

DOOR SPECS

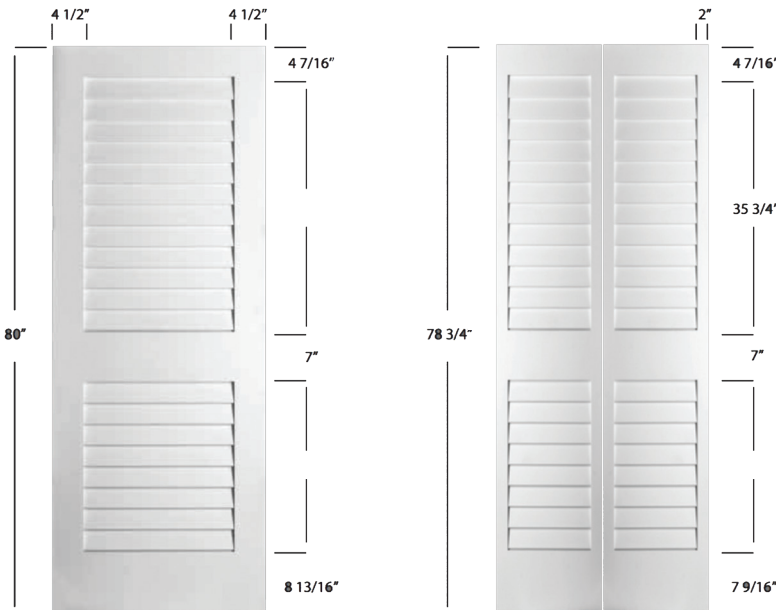

Quickship French Door -MODEL #1501

One Lite Traditional Style Door & Glass Options

*All Quickship are 2 weeks. All other doors are 5 week lead time.

- Handing required on all French Doors
- See Upgrades and Adders below

MODEL #1501

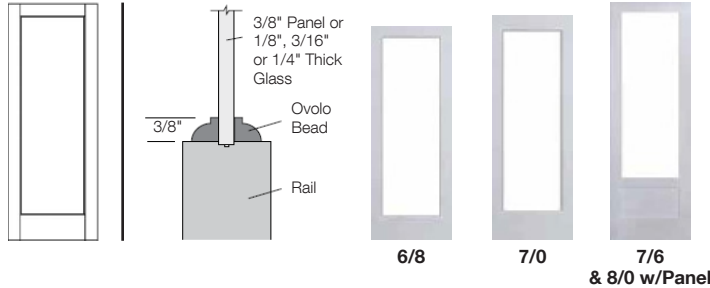

ADDERS	
-APPLIES TO ALL 1501 FRENCH DOORS	
84"	\$145
90"	\$515
96"	\$360
1-3/4" in 80"	\$445
1-3/4" in 84"	\$515
1-3/4" in 90"	\$670
1-3/4" in 96"	\$820

UPGRADE TO MODEL #8601 SHAKER STYLE (80" ONLY)/ \$145

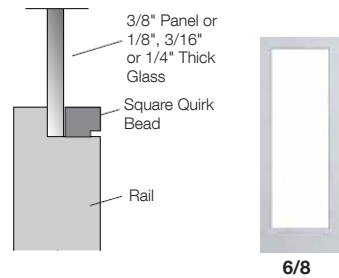

80"H DOORS -QUICKSHIP

		WIDTH	Primed
DWL 1 LITE		24" / 26"	\$515
		28" / 30" / 32"	\$558
		34" / 36"	\$583
		38"	\$806



80"H DOORS -QUICKSHIP

		WIDTH	Primed
PANTRY		24" / 26"	\$566
		28" / 30" / 32"	\$600
		34"	\$626



80"H DOORS -QUICKSHIP

		WIDTH	Primed
HARLOW		24" / 26"	\$858
		28" / 30" / 32"	\$892
		34" / 36"	\$926
		38"	\$1,149

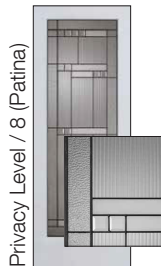

80"H DOORS -QUICKSHIP

		WIDTH	Primed
LEXINGTON		24" / 26"	\$1,063
		28" / 30" / 32"	\$1,106
		34" / 36"	\$1,132
		38"	\$1,149

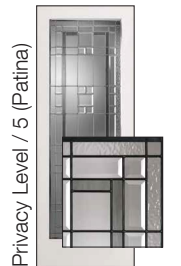

Quickship French Door -MODEL #1501

One Lite Traditional Style Door & Glass Options

*All Quickship are 2 weeks. All other doors are 5 week lead time.

- Handing required on all French Doors

80"H DOORS -QUICKSHIP

WIDTH		Primed
MODENA	24" / 26"	\$815
	28" / 30" / 32"	\$849
	34" / 36"	\$875
	38"	\$1,080



Privacy Level / 7 (Zinc)

80"H DOORS -QUICKSHIP

WIDTH		Primed
BEVELLED 10/15 LITE	24" / 26"	\$652
	28" / 30" / 32"	\$678
	34" / 36"	\$712
	38"	\$943

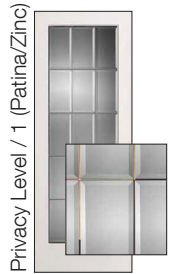

Privacy Level / 1 (Patina/Zinc)

*Left or right glass style must be indicated when ordering.

80"H DOORS -QUICKSHIP

WIDTH		Primed
MADISON	24" / 26"	\$806
	28" / 30" / 32"	\$832
	34" / 36"	\$858
	38"	\$1,080

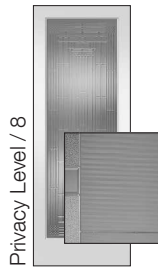

Privacy Level / 8

80"H DOORS -QUICKSHIP

WIDTH		Primed
FLAT GLUE CHIP	24" / 26"	\$583
	28" / 30" / 32"	\$609
	34" / 36"	\$635
	38"	\$943



Privacy Level / 9 (Patina)

80"H DOORS -QUICKSHIP

WIDTH		Primed
CLEAR 1 LITE	24" / 26"	\$429
	28" / 30" / 32"	\$463
	34" / 36"	\$489
	38"	\$712



Privacy Level / 1

80"H DOORS -QUICKSHIP

WIDTH		Primed
MIRROR 1 SIDE	24" / 26"	\$926
	28" / 30" / 32"	\$952
	34" / 36"	\$978
	38"	\$1,200

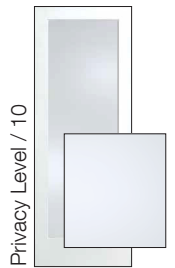

Privacy Level / 10

80"H DOORS -QUICKSHIP

WIDTH		Primed
MIRROR 2 SIDES	24" / 26"	\$935
	28" / 30" / 32"	\$969
	34" / 36"	\$995
	38"	\$1,218

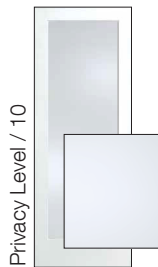

Privacy Level / 10

80"H DOORS -QUICKSHIP

WIDTH		Primed
RIVERTON OBSCURE	24" / 26"	\$669
	28" / 30" / 32"	\$695
	34" / 36"	\$720
	38"	\$952



Privacy Level / 8

Quickship French Door -MODEL #1501

One Lite Traditional Style Door & Glass Options

*All Quickship are 2 weeks. All other doors are 5 week lead time.

- Handing required on all French Doors

80"H DOORS -QUICKSHIP

WIDTH		Primed
SABLE	24" / 26"	\$875
	28" / 30" / 32"	\$900
	34" / 36"	\$935
	38"	\$1,158

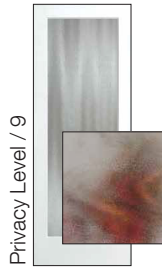

80"H DOORS -QUICKSHIP

WIDTH		Primed
WHEAT	24" / 26"	\$858
	28" / 30" / 32"	\$892
	34" / 36"	\$926
	38"	\$1,149

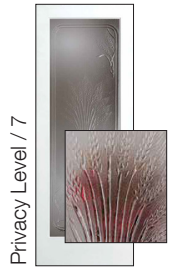

80"H DOORS -QUICKSHIP

WIDTH		Primed
OPEN AND BEADED	24" / 26"	\$352
	28" / 30" / 32"	\$386
	34" / 36"	\$420
	38"	\$643



80"H DOORS -QUICKSHIP

WIDTH		Primed
LAUNDRY	30" / 32"	\$600
	34"	\$626
	36"	\$626
	38"	\$849



80"H DOORS -QUICKSHIP

WIDTH		Primed
NARROW REED	24" / 26"	\$515
	28" / 30" / 32"	\$558
	34" / 36"	\$583
	38"	\$806



80"H DOORS -QUICKSHIP

WIDTH		Primed
RAIN	24" / 26"	\$515
	28" / 30" / 32"	\$558
	34" / 36"	\$583
	38"	\$806



80"H DOORS -QUICKSHIP

WIDTH		Primed
ADELAIDE	24" / 26"	\$1,175
	28" / 30" / 32"	\$1,200
	34" / 36"	\$1,226
	38"	\$1,458



80"H DOORS -QUICKSHIP

WIDTH		Primed
ARTISAN	24" / 26"	\$1,175
	28" / 30" / 32"	\$1,200
	34" / 36"	\$1,226
	38"	\$1,458

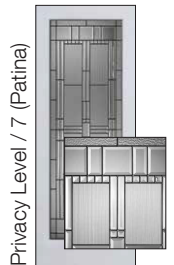

Quickship French Door -MODEL #1501

One Lite Traditional Style Door & Glass Options

*All Quickship are 2 weeks. All other doors are 5 week lead time.

- Handing required on all French Doors

80"H DOORS

DELTA FROST	WIDTH	Primed
	24" / 26"	\$1,243
	28" / 30" / 32"	\$1,278
	34" / 36"	\$1,312
	38"	\$1,535

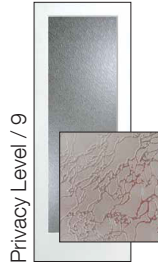

80"H DOORS

HEAVY WATER	WIDTH	Primed
	24" / 26"	\$1,243
	28" / 30" / 32"	\$1,278
	34" / 36"	\$1,312
	38"	\$1,535



80"H DOORS

PINHEAD	WIDTH	Primed
	24" / 26"	\$1,243
	28" / 30" / 32"	\$1,278
	34" / 36"	\$1,312
	38"	\$1,535



80"H DOORS

KASUMI	WIDTH	Primed
	24" / 26"	\$1,243
	28" / 30" / 32"	\$1,278
	34" / 36"	\$1,312
	38"	\$1,535

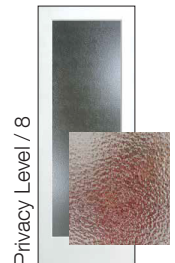

80"H DOORS

SCREEN DOT	WIDTH	Primed
	24" / 26"	\$1,243
	28" / 30" / 32"	\$1,278
	34" / 36"	\$1,312
	38"	\$1,535

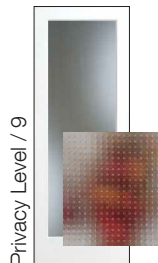

80"H DOORS

SEEDY BAROQUE	WIDTH	Primed
	24" / 26"	\$1,243
	28" / 30" / 32"	\$1,278
	34" / 36"	\$1,312
	38"	\$1,535



Interior Door Handing Sheet

Please check the correct handing below:

For French Doors please check the side the decorative glass is to show on.

SINGLE INSWING INTERIOR DOOR

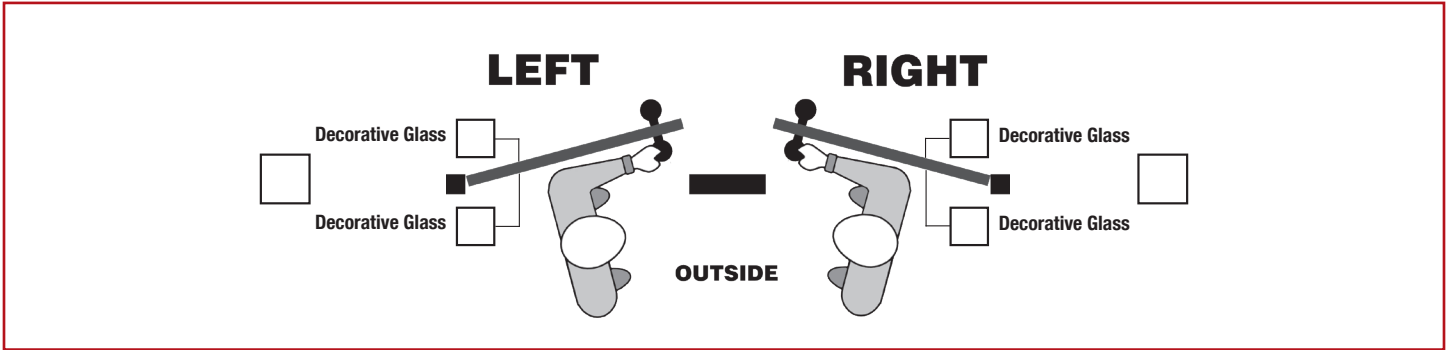

SINGLE OUTSWING INTERIOR DOOR

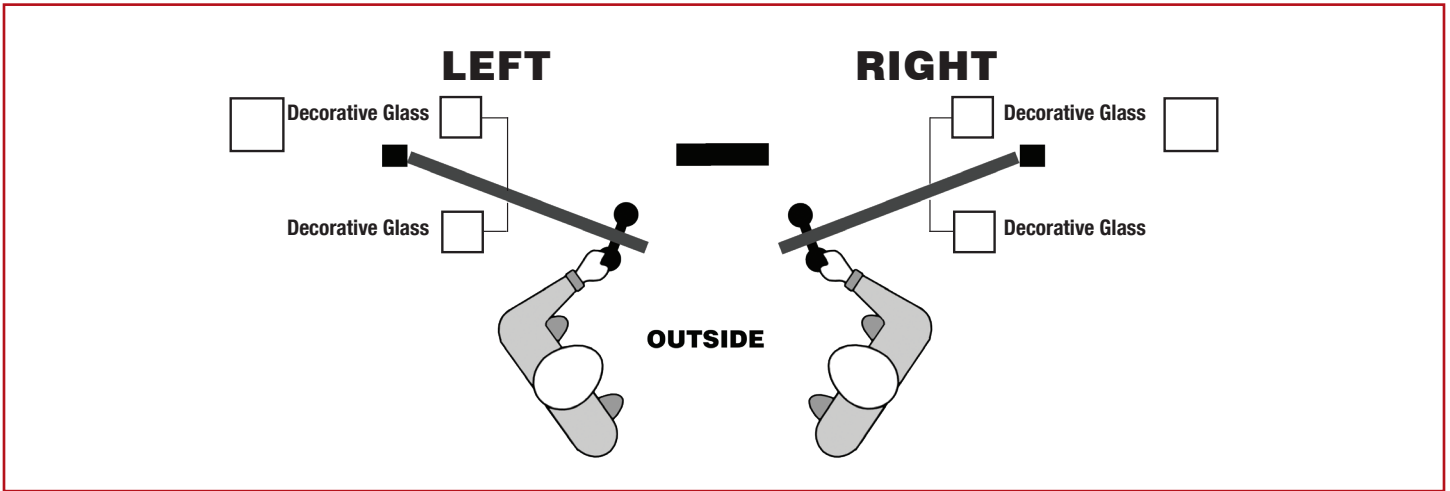

DOUBLE INTERIOR DOOR

INSWING

OUTSWING

VIEW FROM OUTSIDE

Ball Catches (No Astragal) ~OR~ Astragal + Flush Bolt If Astragal is Required: Fingerjoint ~OR~ Pine

Door Machining Reference Sheet

DOOR TYPE / MODÈLE: _____

SIZE/ DIMENSION: _____

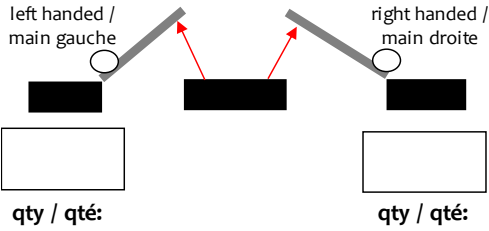

- 1 3/8"
- HOLLOW CORE / ÂME CREUSE
 - SOLID CORE / AMA
 - SWC / AMB

- 1 3/4"
- HOLLOW CORE / ÂME CREUSE
 - SOLID CORE / AMA
 - SWC / AMB
- Fire rated / Coupe-feu
- 20
 - 45
 - 60
 - 90

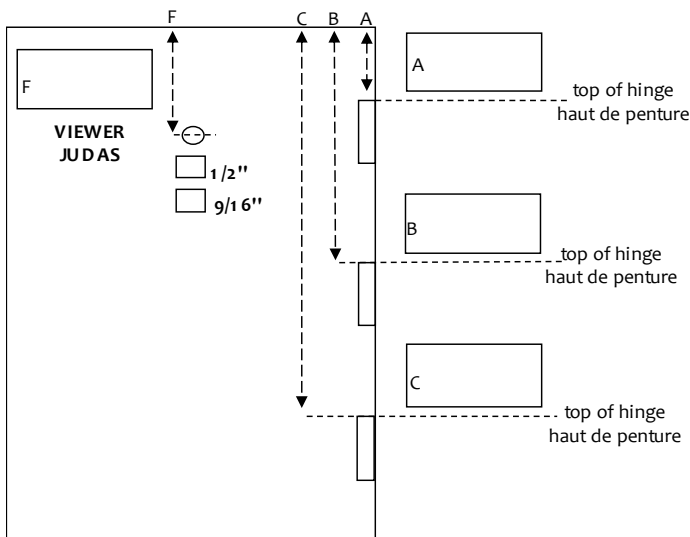

- HINGES / PENTURES
- 5/8" radius rayon 5/8"
 - 1/4" radius rayon 1/4"
 - square carrée
- 3" X 1 3/16" (standard)
 - 3" X 1 1/8" 4" X 1 1/2"
 - 3" X 1 1/4" 4 1/2" X 1 1/2"
 - 3" X 1 3/8" REVERSIBLE
 - 3 1/2" X 1 3/16"
 - 3 1/2" X 1 1/4"

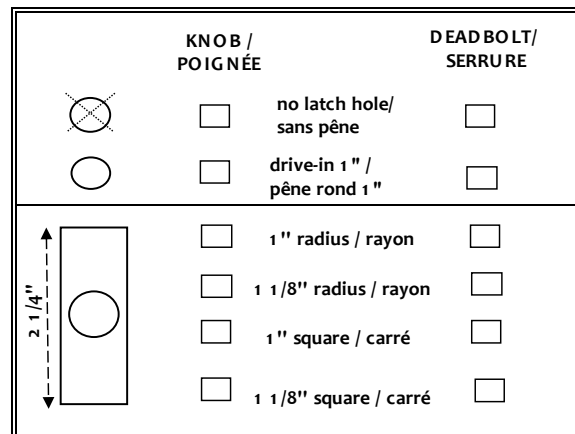
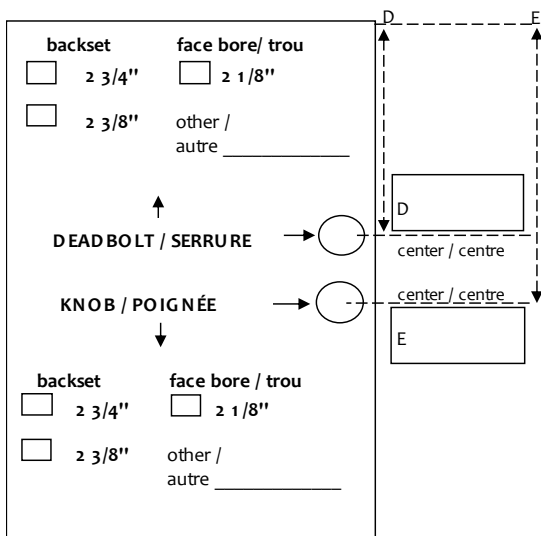

PQ-LIGNE : _____ DATE : _____ SIGNATURE : _____

DO NOT MODIFY THIS FORM / NE PAS MODIFIER LE FORMULAIRE



Doorsmith DIGITAL
COMPLETE DOOR QUOTING SOFTWARE

FOR ALL OF YOUR DOOR PRICING NEEDS
ASK YOUR DOORSMITH SALES REPRESENTATIVE

doorsmith.ca • 1.800.461.5411 • support@doorsmith.ca