

LARSON

DEALER CATALOG



MANIFEST YOUR OUTER HOME





Manifest your outer home.

For more than 70 years, homeowners have turned to Larson to protect and enjoy their homes with our high-quality, high-performance home solutions.

As America's trusted storm door brand, we are committed to inspiring better living at every threshold. A Larson® storm door is so much more than a door — it's a simple addition that elevates your entryway into a place of comfort, safety and style. Whether you're sitting on your porch or walking through your foyer, you can let the best of nature in while keeping the worst of it out.

TABLE OF CONTENTS

4-5	Outdoor Trends & Featured Products	54-87	Retractable Screen Products
6-7	An Introduction to Storm Doors	88-91	Retail Hardware
8-19	Platinum Collection	92-95	Parts & Accessories
20-41	Storm Doors	96-97	Resources
42-45	French Door Kits	98	Index
46-53	Security Storm Doors		



**YELLOWSTONE
FOREVER**

We are proud to be an official corporate partner of Yellowstone Forever's sustainability initiative to help ensure that Yellowstone National Park remains for generations. We're proud to provide fiberglass entryways for Yellowstone Park employee housing.

Where style meets serenity.

Today's design trends invite you to create a relaxing retreat that reflects your home's unique style. Whether you're drawn to nostalgic charm, timeless elegance or laid-back luxury, we offer the products that will help turn your home into a haven.

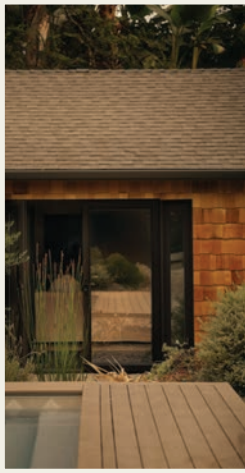

MODERN HARMONY

NOSTALGIC | INDUSTRIAL | ORGANIC

Retro styles meet nature-inspired influences as modern homes lean into lighter hues, warm wood grains and mixed textures.

FEATURED PRODUCTS

150 Maximum View



BALANCED BLEND

CRAFTED | TEXTURAL | WELCOMING

The new casual aesthetic features trend-forward colors and finishes in perfect harmony with elevated but comfortable details like vertical textures and eased edges.

FEATURED PRODUCTS

459 Platinum Interchangeable Full Glass

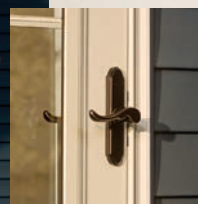

WELL TAILORED

DECORATIVE | TRANSITIONAL | REFINED

Traditional homes blend European-inspired elements with tailored details, including mixed wood grains and a moody color palette, for a fresh take on Old World style.

FEATURED PRODUCTS

830 Lifestyle Midview Screen Away

Find Your New Storm Door

Create the entry that matches your lifestyle from our wide selection of storm doors. Whether you want extra protection for your home, more fresh air and natural light, or freedom for your pet, we have the right door for you.

VENT OPTIONS

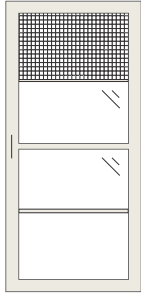

Retractable

Built-in screen offers fresh air or clear views at your fingertips.

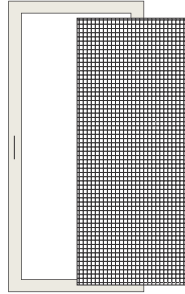

Interchangeable

Included screen opens your home to the best of each season.

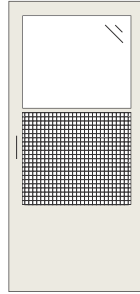

Standard Venting

Built-in screen stays in the window for convenient ventilation.



Pet Door

Pre-installed pet door lets your pet come and go as they please.

VIEW OPTIONS

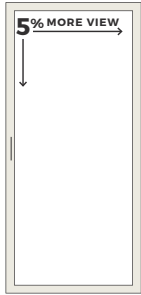

Maximum View

Our largest window opening allows for maximum natural light.

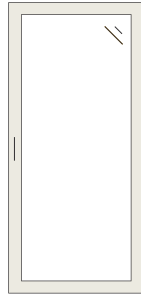

Fullview

The full door is a window with only a frame surrounding it.

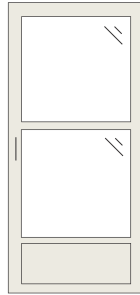

Midview

Most of the door is a window with a small panel at the bottom.

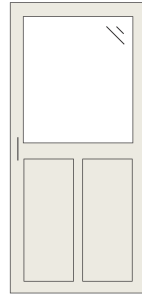

Highview

The door is half window, half panel for extra privacy.

CLOSER STYLES

Closers come in four different styles, and we offer reliable open and close with premium hold-open options. Closers cannot be customized or changed upon door purchase.

EXCLUSIVE INNOVATIONS

SureLatch™ magnetic technology helps securely latch your door every time.

Maximum view doors deliver 5% more view than similar models.



Interior View

Step-to-Hold Closer



Interior View

SureLatch™ Magnetic Technology

¹Preparation time not included. Based on typical installation. Actual times may vary.

PLATINUM SERIES	70-80 SERIES	50-60 SERIES		30-40 SERIES	20 SERIES
PLATINUM COLLECTION	146 EASY VENT SELECTION	150 MAXIMUM VIEW	FULL GLASS & SCREEN	RETRACTABLE SCREEN	STANDARD VENTING

VENT OPTIONS

Premium Interchangeable	●		●		
Premium Retractable	●	●			
Interchangeable				●	
Retractable				●	
Standard Venting					●

VIEW OPTIONS

Maximum View			●		
Fullview	●	●		●	
Midview		●		●	●
Highview		●		●	●

CLOSER OPTIONS

Hidden Push-to-Hold	●				
SureLatch Step-to-Hold			●		
Step-to-Hold		●		●	
Standard				●	●

PREMIUM FEATURES

Premium features included on select models.	10-Minute Install ¹ Premium Aluminum Frame 3X Weatherstrip Multi-Point Locking System	Heavy-Duty Aluminum Frame 2X Weatherstrip	Heavy-Duty Aluminum Frame 2X Weatherstrip		
---	---	--	--	--	--

ADDITIONAL OPTIONS

Check for unique upgrade options on select models.	Security Glass Security Screen Low-E Glass	Low-E Glass Bevel Glass	Neat+™ Glass Low-E Glass Bevel Glass		
--	--	----------------------------	--	--	--

PET OPTIONS

Pre-Installed Pet Door		●			●
------------------------	--	---	--	--	---





Platinum Collection

Experience a truly premium entryway with the advanced features and sleek, modern design of the Platinum Collection.

EXCLUSIVE PLATINUM COLLECTION FEATURES



10-minute install¹ with no experience or special tools required.



Hidden push-to-hold closer holds the door in place with an extra push.



Premium aluminum frame and 3X the weatherstrip seal for ultimate weather protection.



Multi-point locking system secures the door at three critical points.

¹Preparation time not included. Based on typical installation. Actual times may vary.



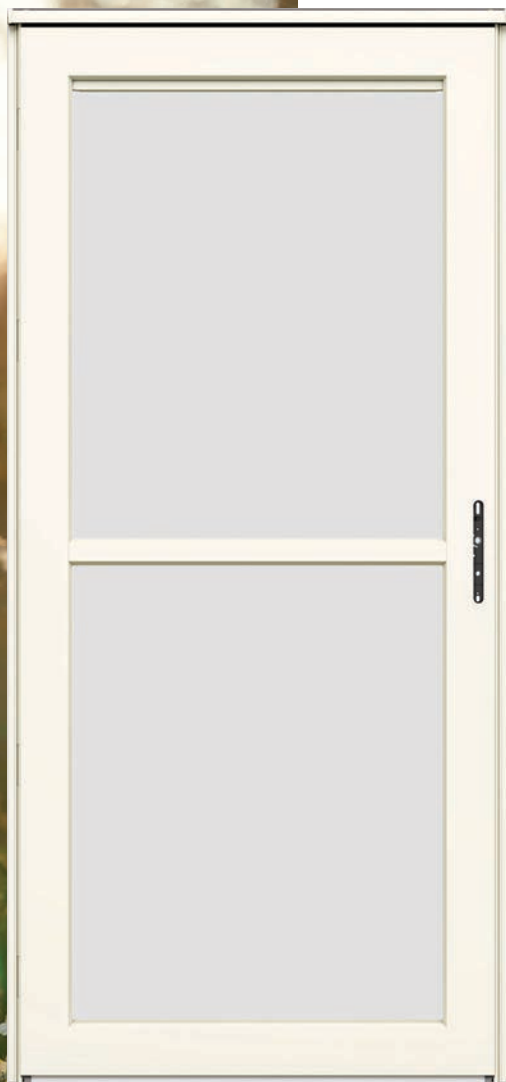

456 Platinum Retractable Screen / Platinum Split Fullview

OUR PREMIUM RETRACTABLE MODEL

Invite fresh air into your home with the touch of a finger and enhance your home's style with the feature-rich and elegant design of the Platinum Collection.

TOP BENEFITS



Fresh air on demand. Fresh air or clear views are at your fingertips with just a pull on the retractable screen.



10-minute install.¹ Out of the box and on your home in six DIY-friendly steps — no experience or special tools required.



Concealed performance. Hold the door in place with just an extra push with the hidden push-to-hold closer.



Robust defense. Shield your entry against harsh weather with a heavy-duty aluminum frame surrounded by 3X the weatherstrip seal for the ultimate weather seal.

ADDITIONAL FEATURES

- Multi-Point Locking System
- Designer screw covers conceal exterior mounting screws
- Pre-Drilled Handleset Holes
- Door Thickness: 1-1/2"
- Pre-Installed Hinges
- Pre-Attached Screw Covers

¹Preparation time not included. Based on typical installation. Actual times may vary.

²Custom doors have extended, variable lead times. Once placed, custom orders cannot be canceled.

³Order in increments of three (same finish) for reduced pricing.

Note: Larson reserves the right to alter or discontinue any model, specification, warranty or price without notice. Product finish colors are approximate; actual finish colors may vary. See your Larson seller or visit larsondoors.com for details on limited warranties and exclusions.

CONFIGURATION AVAILABILITY

MODEL	SIZE	WHITE LINEN	PEBBLESTONE	WOODLAND	GRAPHITE	BLACK
456FVE Low-E	32" x 81" 36" x 81"	●	●	●	●	●
456FV Clear	32" x 81" 36" x 81"	●	●	●	●	●
Regular Custom²						
456FVE Low-E	W: 30" - 40" H: 75" - 86"	●	●	●	●	●
456FV Clear		●	●	●	●	●
Oversize Custom²						
456FVE Low-E	W: up to 32" - 40" H: 86-1/8" - 97"	●	●	●	●	●
456FV Clear		●	●	●	●	●

Retractable Screen

When ordering, select left (L) or right (R) hinge as seen from outside.

FRAME COLORS



QUICKFIT™ HANDLESETS

Sold separately and required to operate the built-in deadbolt on Platinum Collection, 146 Easy Vent® Selection and 150 Maximum View models. QuickFit handlesets cannot be modified for use with older models.



QuickFit Handleset

Available in single and 3-pack³

Straight

- 20298917 Brushed Nickel
- 20298957 Aged Bronze
- 20298953 Matte Black

Curved

- 20297817 Brushed Nickel
- 20297857 Aged Bronze
- 20297807 Brass
- 20297820 Antique Brass
- 20297853 Matte Black

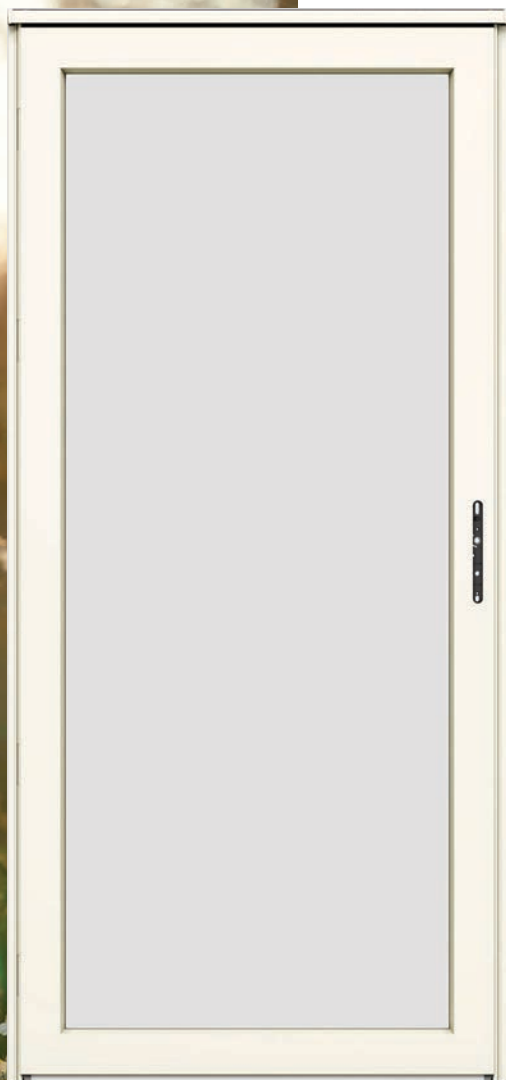

459 Platinum Interchangeable Full Glass / Platinum Fullview

OUR PREMIUM FULL GLASS MODEL

Welcome each season and enhance your home's style with the feature-rich and elegant design of the Platinum Collection.

TOP BENEFITS



Enjoy the best of each season. Let in fresh air when it's warm and natural light when it's cold by easily swapping the included screen and tempered glass panels.



10-minute install.¹ Out of the box and on your home in six DIY-friendly steps — no experience or special tools required.



Concealed performance. Hold the door in place with just an extra push with the hidden push-to-hold closer.



Robust defense. Shield your entry against harsh weather with a heavy-duty aluminum frame surrounded by 3X the weatherstrip seal for the ultimate weather seal.

ADDITIONAL FEATURES

- Multi-Point Locking System
- Pre-Attached Screw Covers
- Pre-Drilled Handleset Holes
- Door Thickness: 1-1/2"
- Pre-Installed Hinges

¹Preparation time not included. Based on typical installation. Actual times may vary.

²Custom doors have extended, variable lead times. Once placed, custom orders cannot be canceled.

³Order in increments of three (same finish) for reduced pricing.

Note: Larson reserves the right to alter or discontinue any model, specification, warranty or price without notice. Product finish colors are approximate; actual finish colors may vary. See your Larson seller or visit larsondoors.com for details on limited warranties and exclusions.

CONFIGURATION AVAILABILITY

MODEL	SIZE	WHITE LINEN	PEBBLESTONE	WOODLAND	GRAPHITE	BLACK
459FVE Low-E	32" x 81" 36" x 81"	●	●	●	●	●
459FV Clear	32" x 81" 36" x 81"	●	●	●	●	●
Regular Custom²						
459FVE Low-E	W: 24" - 36" H: 75" - 85"	●	●	●	●	●
459FV Clear		●	●	●	●	●
Oversize Custom²						
459FVE Low-E	W: 36-1/8" - 42" H: 75" - 85"	●	●	●	●	●
459FV Clear		●	●	●	●	●
Oversize Plus Custom²						
459FVE Low-E	W: up to 42" H: 85-1/8" - 97"	●	●	●	●	●
459FV Clear		●	●	●	●	●



Interchangeable
Screen & Glass

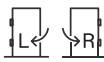

When ordering, select left (L) or
right (R) hinge as seen from outside.



FRAME COLORS



White Linen



Pebblestone



Woodland



Graphite



Black

QUICKFIT™ HANDLESETS

Sold separately and required to operate the built-in deadbolt on Platinum Collection, 146 Easy Vent® Selection and 150 Maximum View models. QuickFit handlesets cannot be modified for use with older models.

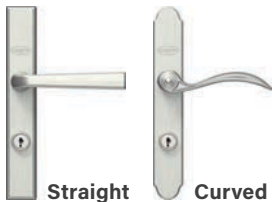

Straight

Curved



Brushed
Nickel



Aged
Bronze



Matte
Black



Brass



Antique
Brass

— Curved Only —

QuickFit Handleset

Available in single
and 3-pack³

Straight

20298917 Brushed Nickel
20298957 Aged Bronze
20298953 Matte Black

Curved

20297817 Brushed Nickel
20297857 Aged Bronze
20297807 Brass
20297820 Antique Brass
20297853 Matte Black

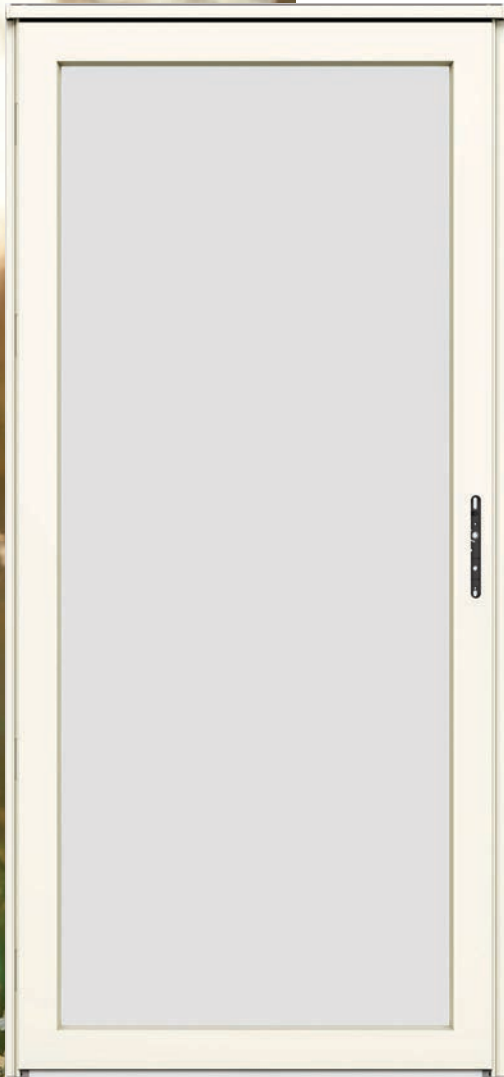

449 Platinum Secure Glass

OUR PREMIUM SECURITY STORM DOOR

Give your entry an exceptional layer of security while maximizing your home's natural light and style with the feature-rich and elegant design of the Platinum Collection.

TOP BENEFITS



Enhanced security, great view. Safeguard your home with a clear inner shield that can help prevent break-ins without obstructing your view.



10-minute install.¹ Out of the box and on your home in six DIY-friendly steps — no experience or special tools required.



Concealed performance. Hold the door in place with just an extra push with the hidden push-to-hold closer.



Robust defense. Shield your entry against harsh weather with a heavy-duty aluminum frame surrounded by 3X the weatherstrip seal for the ultimate weather seal.

ADDITIONAL FEATURES

- Multi-Point Locking System
- Pre-Attached Screw Covers
- Pre-Drilled Handleset Holes
- Door Thickness: 1-1/2"
- Pre-Installed Hinges

¹Preparation time not included. Based on typical installation. Actual times may vary.

²Custom doors have extended, variable lead times. Once placed, custom orders cannot be canceled.

³Order in increments of three (same finish) for reduced pricing.

Note: Larson reserves the right to alter or discontinue any model, specification, warranty or price without notice. Product finish colors are approximate; actual finish colors may vary. See your Larson seller or visit larsondoors.com for details on limited warranties and exclusions.

CONFIGURATION AVAILABILITY

MODEL	SIZE	WHITE LINEN	PEBBLESTONE	WOODLAND	GRAPHITE	BLACK
449-04 Clear	32" x 81" 36" x 81"	●	●	●	●	●
Regular Custom²						
449-04 Clear	W: 24" - 36" H: 75" - 85"	●	●	●	●	●
Oversize Custom²						
449-04 Clear	W: 36-1/8" - 42" H: 75" - 85"	●	●	●	●	●
Oversize Plus Custom²						
449-04 Clear	W: 24" - 42" H: 85-1/8" - 97"	●	●	●	●	●

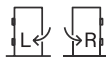

When ordering, select left (L) or right (R) hinge as seen from outside.



FRAME COLORS

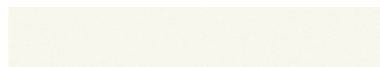

White Linen



Pebblestone



Woodland



Graphite



Black

QUICKFIT™ HANDLESETS

Sold separately and required to operate the built-in deadbolt on Platinum Collection, 146 Easy Vent, Selection and 150 Maximum View models. QuickFit handlesets cannot be modified for use with older models.

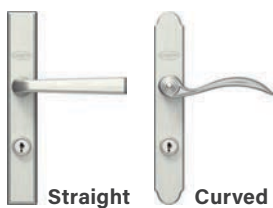

Straight

Curved



Brushed Nickel



Aged Bronze



Matte Black



Brass



Antique Brass

— Curved Only —

QuickFit Handleset

Available in single and 3-pack³

Straight

20298917 Brushed Nickel
20298957 Aged Bronze
20298953 Matte Black

Curved

20297817 Brushed Nickel
20297857 Aged Bronze
20297807 Brass
20297820 Antique Brass
20297853 Matte Black

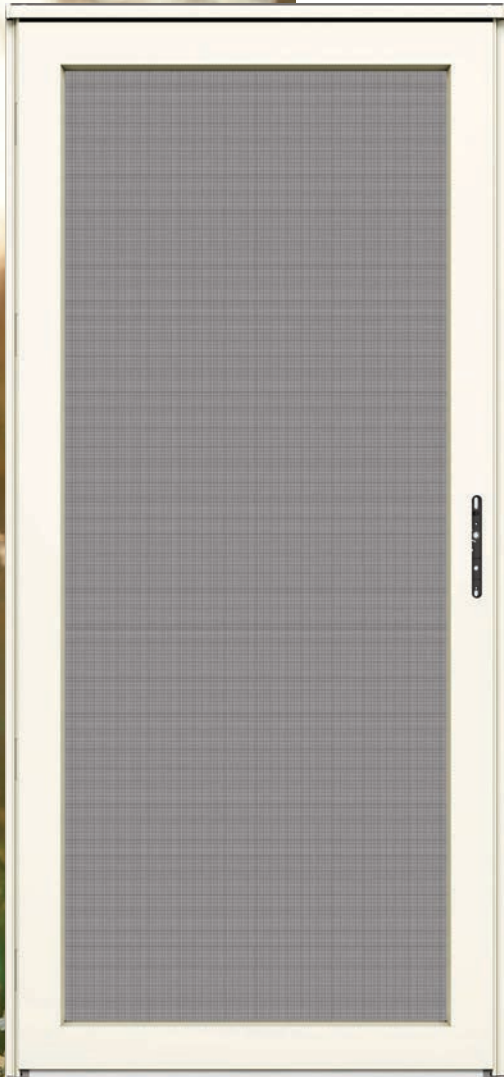

450 Platinum Secure Screen

OUR PREMIUM SECURITY SCREEN DOOR

Give your entry an exceptional layer of security without sacrificing ventilation or your home's style with the feature-rich and elegant design of the Platinum Collection.

TOP BENEFITS



Security, refreshed. Enhance your home's security and ventilation with stainless steel mesh that can help prevent break-ins.



10-minute install.¹ Out of the box and on your home in six DIY-friendly steps — no experience or special tools required.



Concealed performance. Hold the door in place with just an extra push with the hidden push-to-hold closer.



Robust defense. Defend your entry with a heavy-duty aluminum frame engineered for long-lasting protection.

ADDITIONAL FEATURES

- Multi-Point Locking System
- Pre-Drilled Handleset Holes
- Pre-Installed Hinges
- Pre-Attached Screw Covers
- Designer screw covers conceal exterior mounting screws
- Door Thickness: 1-1/2"

¹Preparation time not included. Based on typical installation. Actual times may vary.

²Custom doors have extended, variable lead times. Once placed, custom orders cannot be canceled.

³Order in increments of three (same finish) for reduced pricing.

Note: Larson reserves the right to alter or discontinue any model, specification, warranty or price without notice. Product finish colors are approximate; actual finish colors may vary. See your Larson seller or visit larsondoors.com for details on limited warranties and exclusions.

CONFIGURATION AVAILABILITY

MODEL	SIZE	WHITE LINEN	PEBBLESTONE	WOODLAND	GRAPHITE	BLACK
450-18	32" x 81" 36" x 81"	●	●	●	●	●
Regular Custom²						
450-18	W: 24" - 36" H: 75" - 85"	●	●	●	●	●
Oversize Custom²						
450-18	W: 36-1/8" - 42" H: 75" - 85"	●	●	●	●	●
Oversize Plus Custom²						
450-18	W: 24" - 42" H: 85-1/8" - 97"	●	●	●	●	●

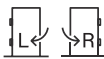

When ordering, select left (L) or right (R) hinge as seen from outside.



FRAME COLORS

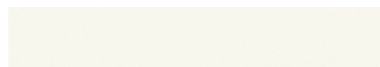

White Linen



Pebblestone



Woodland



Graphite



Black

QUICKFIT™ HANDLESETS

Sold separately and required to operate the built-in deadbolt on Platinum Collection, 146 Easy Vent. Selection and 150 Maximum View models. QuickFit handlesets cannot be modified for use with older models.

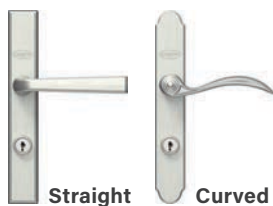

Straight

Curved



Brushed Nickel



Aged Bronze



Matte Black



Brass



Antique Brass

— Curved Only —

QuickFit Handleset

Available in single and 3-pack³

Straight

20298917 Brushed Nickel
20298957 Aged Bronze
20298953 Matte Black

Curved

20297817 Brushed Nickel
20297857 Aged Bronze
20297807 Brass
20297820 Antique Brass
20297853 Matte Black

Measuring Guide

PLATINUM STORM & SECURITY DOORS

The Platinum Collection features our easiest storm door installation system. Use the diagram on the right to record your measurements as shown. If the width measurements vary, record the smallest measurement.

SURFACE MOUNT

The rails mount directly to the face of the exterior door trim and require 3/4" of clearance on each side and up to 1" of clearance above the opening.

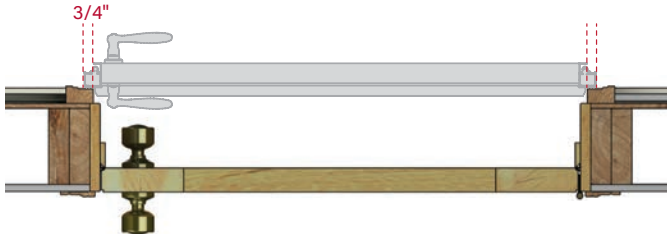

Construction styles may vary.

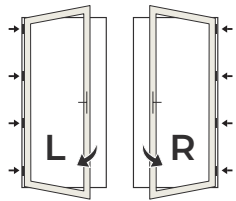

PRE-HINGED FOR EFFORTLESS INSTALLATION

Select **L** (left-hinge) or **R** (right-hinge) as viewed from outside when ordering.

Look for this icon.

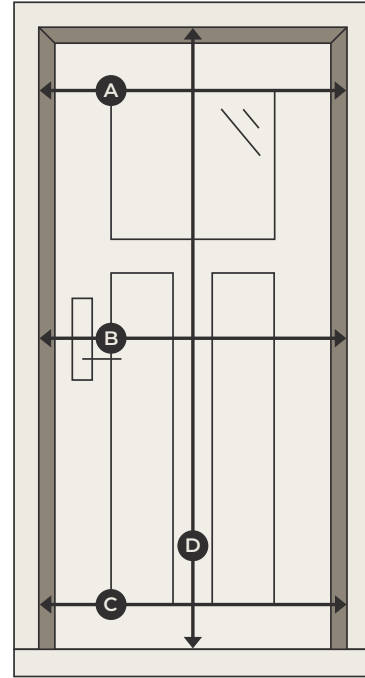

RECORD MEASUREMENTS

A	Width	C	Width
B	Width	D	Height

SPECIFY WHEN ORDERING

- A.** Model Number
- B.** Color
- C.** Required Opening Size (Width x Height)
- D.** Platinum Hinge Side (LH or RH)

DOOR OPENING	MIN. WIDTH	MAX. WIDTH	MIN. HEIGHT	MAX. HEIGHT
32" x 81"	31-7/8"	32-3/8"	80"	81"
36" x 81"	35-7/8"	36-3/8"		

Note: Standard size availability varies by model. Custom size doors are made to fit opening size ordered. Custom doors have extended, variable lead times. Once placed, custom orders cannot be canceled. Shims may be required in certain installation applications.





146 Easy Vent® Selection / Larson 80 Split Fullview

TOP BENEFITS



Fresh air on demand. Fresh air or clear views are at your fingertips with just a pull on the retractable screen.



Hands-free convenience. Reliable closure and hands-free movement through the entry with a tap on the step-to-hold closer.



Enduring protection. The heavy-duty aluminum frame surrounded by 2X the weatherstrip seal shields your entry against the elements.

ADDITIONAL FEATURES

- Two-Closer System
- Overlapping Frame Edge
- Balanced Window System
- **146PV** – 8" x 12" Pet Door
- Designer screw covers conceal exterior mounting screws.
- Door Thickness: 1-7/8"³

Fullview with Low-E/Clear
146FVE | 146FV

FRAME COLORS



White

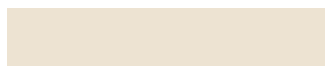

Almond



Sandstone



Brown



Graphite



Black

AVAILABLE MODELS



Pet Fullview
146PV



Bevel Glass
146BV



Midview
146MV



Highview
146HV





¹Custom doors have extended, variable lead times. Once placed, custom orders cannot be canceled.

²Order in increments of three (same finish) for reduced pricing.

³Thickness may vary based on handleset style selection.

Note: Larson reserves the right to alter or discontinue any model, specification, warranty or price without notice. Product finish colors are approximate; actual finish colors may vary. See your Larson seller or visit larsondoors.com for details on limited warranties and exclusions.

CONFIGURATION AVAILABILITY

MODEL	SIZE	WHITE	ALMOND	SANDSTONE	BROWN	GRAPHITE	BLACK	
146FVE Low-E	32" x 81" 36" x 81"	●	●	●	●	●	●	
	34" x 81"	●						
146FV Clear	32" x 81" 36" x 81"	●	●	●	●	●	●	
	30" x 81"	●						
	34" x 81"	●		●	●		●	
146PV Pet Door	32" x 81" 36" x 81"	●	●	●	●		●	
146BV Bevel	36" x 81"	●	●	●	●		●	
146MV Midview	32" x 81" 36" x 81"	●	●	●	●		●	
	34" x 81"	●		●	●		●	
146HV Highview	32" x 81" 36" x 81"	●	●	●	●			
Regular Custom¹								
146FVE Low-E	W: 30" - 40" H: 70" - 86"	●	●	●	●	●	●	
146FV Clear		●	●	●	●	●	●	
Oversize Custom¹								
146FVE Low-E	W: 32" - 40" H: 86-1/8" - 97"	●	●	●	●	●	●	
146FV Clear		●	●	●	●	●	●	
  Retractable Screen  Easy Left- or Right-Hinge Installation  French Door Kit Available Refer to charts on pages 42-45. 								

QUICKFIT™ HANDLESETS

Sold separately and required to operate the built-in deadbolt on Platinum Collection, 146 Easy Vent® Selection and 150 Maximum View models. QuickFit handlesets cannot be modified for use with older models.

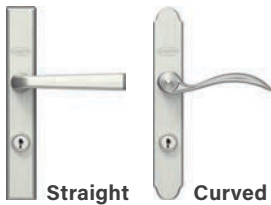

QuickFit Handleset

Available in single and 3-pack²

- Straight**
 20298917 Brushed Nickel
 20298957 Aged Bronze
 20298953 Matte Black

- Curved**
 20297817 Brushed Nickel
 20297857 Aged Bronze
 20297807 Brass
 20297820 Antique Brass
 20297853 Matte Black



356 Lifestyle Fullview Screen Away®/ Larson 70 Split Fullview

TOP BENEFITS



Fresh air on demand. Fresh air or clear views are at your fingertips with just a pull on the retractable screen.



Low-maintenance durability. The durable aluminum frame and heavy-duty weatherstrip provide complete entry protection.

ADDITIONAL FEATURES

- Standard Closer
- Handleset with Keyed Lock
- Designer screw covers conceal exterior mounting screws.
- Door Thickness: 1-3/8"



FRAME COLORS

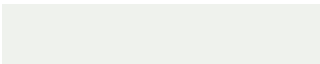

White

CONFIGURATION AVAILABILITY

MODEL	SIZE	WHITE
356-52 Brushed Nickel	32" x 81"	●
356-60 Brass	34" x 81"	
	36" x 81"	



Retractable Screen



Easy Left- or Right-Hinge Installation



Note: Larson reserves the right to alter or discontinue any model, specification, warranty or price without notice. Product finish colors are approximate; actual finish colors may vary. See your Larson seller or visit larsondoors.com for details on limited warranties and exclusions. Custom doors have extended, variable lead times. Once placed, custom orders cannot be canceled.



Maximum View with Low-E/Clear
150FXE | 150FX

FRAME COLORS



White

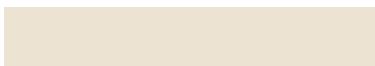

Almond



Sandstone



Brown



NEW Bordeaux



Graphite



Black

150 Maximum View / Larson 60 MT Maximum View

TOP BENEFITS



An unmatched view. Enjoy maximum natural light through our largest window opening. Easily swap in the included screen for seasonal fresh air.



Magnetic closure. Listen for the click as SureLatch™ magnetic technology helps your door close with a smooth, confident latch for years to come.



Enduring protection. The heavy-duty aluminum frame surrounded by 2X the weatherstrip seal shields your entry against the elements.

UPGRADE OPTIONS

- Neat+™ Low-E Glass – Designed to help keep glass clear and free of watermarks, reducing the need for cleaning.
- BetterVue. Screen – Wicks away water and grime for a clear view.

ADDITIONAL FEATURES

- SureLatch Step-to-Hold Closer
- Minimalist, Modern Design
- Overlapping Frame Edge
- Designer screw covers conceal exterior mounting screws.
- Door Thickness: 1-5/8"

NEXT-GEN MAGNETIC CLOSER, EXCLUSIVE TO LARSON

Magnets on the storm door and the head jamb work together to pull your door shut. Even when seasonal temperature changes affect other storm doors, SureLatch maintains a smooth, reliable closure.



AVAILABLE MODELS

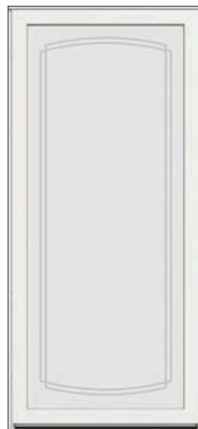

Bevel Glass
150BX

150 Maximum View *continued*

CONFIGURATION AVAILABILITY

MODEL	SIZE	WHITE	ALMOND	SANDSTONE	BROWN	BORDEAUX	GRAPHITE	BLACK
150FXE Low-E	32" x 81" 36" x 81"	●	●	●	●	●	●	●
150FX Clear	32" x 81" 36" x 81"	●	●	●	●	●	●	●
	30" x 81"	●			●			●
	34" x 81"	●						
150BX Bevel	32" x 81" 36" x 81"	●	●	●	●		●	●
Regular Custom¹								
150FXE Low-E	W: 24" - 36" H: 70" - 85"	●	●	●	●		●	●
150FX Clear		●	●	●	●		●	●
150FXN Low-E Neat+™		●	●	●	●		●	●
150FXEB Low-E with BetterVue Screen		●	●	●	●		●	●
150FXB Clear with BetterVue® Screen		●	●	●	●		●	●
150FXNB Low-E Neat+ with BetterVue Screen		●	●	●	●		●	●

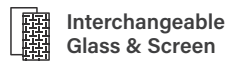

QUICKFIT™ HANDLESETS

Sold separately and required to operate the built-in deadbolt on Platinum Collection, 146 Easy Vent® Selection and 150 Maximum View models. QuickFit handlesets cannot be modified for use with older models.



QuickFit Handleset

Available in single and 3-pack²

Straight
 20298917 Brushed Nickel
 20298957 Aged Bronze
 20298953 Matte Black

Curved
 20297817 Brushed Nickel
 20297857 Aged Bronze
 20297807 Brass
 20297820 Antique Brass
 20297853 Matte Black

¹Custom doors have extended, variable lead times. Once placed, custom orders cannot be canceled. Custom doors require hinge side preference upon ordering.

²Order in increments of three (same finish) for reduced pricing.

Note: Larson reserves the right to alter or discontinue any model, specification, warranty or price without notice. Product finish colors are approximate; actual finish colors may vary. See your Larson seller or visit larsondoors.com for details on limited warranties and exclusions.

MODEL	SIZE	WHITE	ALMOND	SANDSTONE	BROWN	BORDEAUX	GRAPHITE	BLACK
Oversize Custom¹								
150FXE Low-E	W: 36-1/8" - 42" H: 70" - 85"	●	●	●	●		●	●
150FX Clear		●	●	●	●		●	●
150FXN Low-E Neat+		●	●	●	●		●	●
150FXEB Low-E with BetterVue Screen		●	●	●	●		●	●
150FXB Clear with BetterVue Screen		●	●	●	●		●	●
150FXNB Low-E Neat+ with BetterVue Screen		●	●	●	●		●	●
Oversize Plus Custom¹								
150FXE Low-E	W: 24" - 42" H: 85-1/8" - 97"	●	●	●	●		●	●
150FX Clear		●	●	●	●		●	●
150FXN Low-E Neat+		●	●	●	●		●	●
150FXEB Low-E with BetterVue Screen		●	●	●	●		●	●
150FXB Clear with BetterVue Screen		●	●	●	●		●	●
150FXNB Low-E Neat+ with BetterVue Screen		●	●	●	●		●	●



Above: 150FX, White Frame with Curved Brass QuickFit Handleset



350 Classic-View Fullview / Larson 50 Fullview

TOP BENEFITS



Enjoy the best of each season. Let in fresh air when it's warm and natural light when it's cold by easily swapping the included screen and tempered glass panels.



Low-maintenance durability. The durable aluminum frame and heavy-duty weatherstrip provide complete entry protection.

ADDITIONAL FEATURES

- Standard Closer
- Handleset with Deadbolt Lock
- Door Thickness: 1-1/4"



FRAME COLORS



White

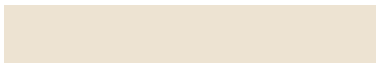

Almond



Sandstone



Brown



Black

CONFIGURATION AVAILABILITY

MODEL	SIZE	WHITE	ALMOND	SANDSTONE	BROWN	BLACK
350-17 Brushed Nickel	32" x 81"	●	●	●	●	●
350-04 Brass	36" x 81"	●	●	●	●	●



**Interchangeable
Glass & Screen**



**Easy Left- or Right-Hinge
Installation**



French Door Kit Available
Refer to charts on pages 42-45.



¹Custom doors have extended, variable lead times. Once placed, custom orders cannot be canceled. Custom doors require hinge side preference upon ordering

Note: Larson reserves the right to alter or discontinue any model, specification, warranty or price without notice. Product finish colors are approximate; actual finish colors may vary. See your Larson seller or visit larsondoors.com for details on limited warranties and exclusions.



830 Lifestyle Midview Screen Away® / Larson 40 Midview

TOP BENEFITS



Fresh air on demand. Fresh air or clear views are at your fingertips with just a pull on the retractable screen.



Seal out the elements. The low-maintenance composite surface and heavy-duty weatherstrip deliver weather-resistant protection.

ADDITIONAL FEATURES

- Standard Closer
- Magnetic Weatherstrip
- Solid Wood Core
- Handleset with Inside Lock
- Door Thickness: 1"



FRAME COLORS

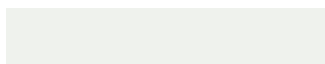

White

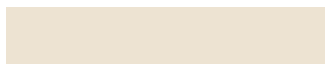

Almond



Sandstone



Brown

CONFIGURATION AVAILABILITY

MODEL	SIZE	WHITE	ALMOND	SANDSTONE	BROWN
830-82 Brushed Nickel	32" x 81"				
830-85 Aged Bronze	34" x 81"	●	●	●	●
830-80 Brass	36" x 81"				
Regular Custom¹					
830-82, 830-85, 830-80	W: 30" – 36" H: 67-1/2" – 85"	●	●	●	●
Oversize Plus Custom¹ Specify hinge side as viewed from outside.					
830-82, 830-85, 830-80	W: 36-1/8" – 42" H: 85-1/8" – 90"	●			●



Retractable Screen



Easy Left- or Right-Hinge Installation



French Door Kit Available
Refer to charts on pages 42–45.

CUSTOM DOORS

- Glass insert size remains standard; frame size adjusts for custom order.
- Maximum size: 42" x 90" uses same size glass insert as standard 36" x 81".
- Minimum size: 30" x 67-1/2" uses same size glass insert as 32" x 81" door.
- Moldings are NOT available on models with opening heights under 77-1/2".



360-48 WearTuff® Full Screen

TOP BENEFITS



Worry-free air. Durable ventilation through a WearTuff screen that is reinforced in frame to resist tearing.



Low-maintenance durability. The durable aluminum frame and heavy-duty weatherstrip provide complete entry protection.

ADDITIONAL FEATURES

- Standard Closer
- Mounting Rail Weatherstrip
- Color-Matched Handleset with Inside Lock
- Door Thickness: 1-1/4"



White Model



Brown Model



Exterior View:
WearTuff Mesh Screen

FRAME COLORS



White



Brown

UPGRADE SCREEN OPTIONS

PetScreen®

Tear- and puncture-resistant screen built with your pet in mind.



PetScreen

No-See-Um

Tight mesh guards against small insects.



No-See-Um

SunTex. 80

Provides approximately 75% UV blockage for shade and privacy.



SunTex 80 | Stucco



SunTex 80 | Gray



SunTex 80 | Black

¹Custom doors have extended, variable lead times. Once placed, custom orders cannot be canceled.

Note: Larson reserves the right to alter or discontinue any model, specification, warranty or price without notice. Product finish colors are approximate; actual finish colors may vary. See your Larson seller or visit larsondoors.com for details on limited warranties and exclusions. Screen not intended to keep children or pets inside.

CONFIGURATION AVAILABILITY

MODEL	SIZE	WEARTUFF		UPGRADE SCREEN OPTIONS	
		WHITE	BROWN	White	Brown
360-48	32" x 81" 36" x 81"	●	●	●	●
Regular Custom¹					
360-48	W: 24" - 36" H: 75" - 85"	●	●	●	●
Oversize Custom¹					
360-48	W: 36-1/8" - 42" H: 70" - 85"	●	●		
Oversize Plus Custom¹					
360-48	W: 24" - 42" H: 85-1/8" - 97"	●	●	● (W: 24" - 36")	●



WearTuff
Screen



Easy Left- or Right-Hinge
Installation



French Door Kit Available
Refer to charts on pages 42-45.





691 Lifestyle Highview Screen Away® / Larson 35 Highview

TOP BENEFITS



Fresh air on demand. Fresh air or clear views are at your fingertips with just a pull on the retractable screen.



Reliable from open to close. Controlled door swing and close assist with two standard closers.



Seal out the elements. The low-maintenance composite surface and heavy-duty weatherstrip deliver weather-resistant protection.

ADDITIONAL FEATURES

- Magnetic Weatherstrip
- Solid Wood Core
- Handleset with Keyed Lock
- Door Thickness: 1"



Brushed Nickel



Aged Bronze



Brass

FRAME COLORS

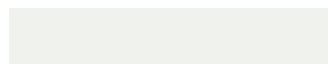

White



Sandstone



Brown

CONFIGURATION AVAILABILITY

MODEL	SIZE	WHITE	SANDSTONE	BROWN
691-52 Brushed Nickel 691-55 Aged Bronze 691-90 Brass	32" x 81" 36" x 81"	●	●	●
Regular Custom¹ Specify hinge side as viewed from outside if over 85".				
691-52, 691-55, 691-90	W: 29" - 36" H: 52" - 90"	●	●	●



Retractable Screen



Easy Left- or Right-Hinge Installation

10 YEAR
LIMITED WARRANTY



French Door Kit Available
Refer to charts on pages 42-45.

CUSTOM DOORS

- Glass insert size remains standard; frame size adjusts for custom order.
- Maximum size: 36" x 90" uses same size glass insert as standard 36" x 81".
- Minimum size: 29" x 52" uses same size glass insert as 32" x 81" door.
- Moldings are NOT available on models with opening heights under 77-1/2".



¹Custom doors have extended, variable lead times. Once placed, custom orders cannot be canceled.

Note: Larson reserves the right to alter or discontinue any model, specification, warranty or price without notice. Product finish colors are approximate; actual finish colors may vary. See your Larson seller or visit larsondoors.com for details on limited warranties and exclusions.



370-84 Lifestyle 2.0 Midview Screen Away® / Larson 30 Midview

TOP BENEFITS

-  **Fresh air on demand.** Fresh air or clear views are at your fingertips with just a pull on the retractable screen.
-  **Hands-free convenience.** Reliable closure and hands-free movement through the entry with a tap on the step-to-hold closer.
-  **Seal out the elements.** The low-maintenance composite surface and heavy-duty weatherstrip deliver weather-resistant protection.

ADDITIONAL FEATURES

- Minimalist, Modern Design
- Solid Wood Core
- Handleset with Keyed Lock
- Door Thickness: 1"

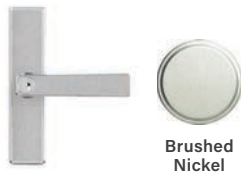

FRAME COLORS



White

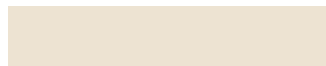

Almond



Brown

CONFIGURATION AVAILABILITY

MODEL	SIZE	WHITE	ALMOND	BROWN
370-84 Brushed Nickel	32" x 81" 36" x 81"	●	●	●
	30" x 81" 34" x 81"	●	●	●



Retractable Screen



Easy Left- or Right-Hinge Installation

10 YEAR LIMITED WARRANTY



French Door Kit Available
Refer to charts on pages 42-45.



360-79 Classic-View Pet View / Larson 25 Pet Fullview

TOP BENEFITS



Pet independence. Let your pet come and go as they please with a pre-installed 10" x 17" pet door for pets up to 100 lbs. Can be secured with included slide-in cover.



Flexible ventilation. Let fresh air flow through the top or bottom window with the tear-resistant WearTuff® Reversa Screen.



Low-maintenance durability. The durable aluminum frame and heavy-duty weatherstrip provide complete entry protection.

ADDITIONAL FEATURES

- Standard Closer
- Color-Matched Handleset with Inside Lock
- Pet-Height Bottom Glass
- Door Thickness: 1-1/4"



Includes slide-in panel cover to secure pet flap.

FRAME COLORS

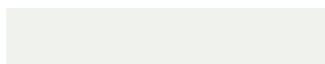

White



Brown

CONFIGURATION AVAILABILITY

MODEL	SIZE	WHITE	BROWN
360-79	32" x 81" 36" x 81"	●	●



WearTuff®
Reversa Screen





Easy Left- or Right-Hinge
Installation





360-49 Pet Breeze

TOP BENEFITS

-  **Pet independence.** Let your pet come and go as they please with a pre-installed 10" x 17" pet door for pets up to 100 lbs. Can be secured with included slide-in cover.
-  **Pet-proof ventilation.** Fresh air that even pets can enjoy through the puncture- and tear-resistant PetScreen®.
-  **Low-maintenance durability.** The durable aluminum frame and heavy-duty weatherstrip provide complete entry protection.

ADDITIONAL FEATURES

- Standard Closer
- Color-Matched Handleset with Inside Lock
- Pet-Height Bottom Screen
- Door Thickness: 1-1/4"



Includes slide-in panel cover to secure pet flap.

FRAME COLORS

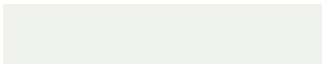

White



Brown

CONFIGURATION AVAILABILITY

MODEL	SIZE	WHITE	BROWN
360-49	32" x 81" 36" x 81"	●	●



370 Life-Core® Pet Single-Vent / Larson 20 Pet Highview

TOP BENEFITS



Pet independence. Let your pet come and go as they please with a pre-installed pet door available in two sizes. Can be secured with included slide-in cover.



Open to fresh air. Welcome in fresh air through the built-in bottom screen.



Seal out the elements. The low-maintenance composite surface and heavy-duty weatherstrip deliver weather-resistant protection.

ADDITIONAL FEATURES

- 370-79 – 10" x 17" Pet Door
- 370-78 – 14" x 23" Pet Door
- Color-Matched Handleset with Inside Lock
- Standard Closer
- Solid Wood Core
- Door Thickness: 1"



Includes slide-in panel cover to secure pet flap.

FRAME COLORS

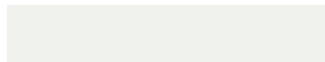

White

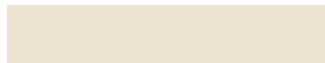

Almond

AVAILABLE MODELS



Flap Opening:
10" x 17" | ≤ 100 lbs.
370-79



Flap Opening:
14" x 23" | ≤ 220 lbs.
370-78

¹Custom doors have extended, variable lead times. Once placed, custom orders cannot be canceled.

Note: Larson reserves the right to alter or discontinue any model, specification, warranty or price without notice. Product finish colors are approximate; actual finish colors may vary. See your Larson seller or visit larsondoors.com for details on limited warranties and exclusions. Pet flap not intended for child use or to keep children or pets inside.

CONFIGURATION AVAILABILITY

MODEL	SIZE	WHITE	ALMOND
370-79 10" x 17" Pet Door	32" x 81" 36" x 81"	●	●
370-78 14" x 23" Pet Door		●	●
Regular Custom¹			
370-79 10" x 17" Pet Door	W: 28" - 36" H: 71-1/2" - 85"	●	●
370-78 14" x 23" Pet Door	W: 28" - 36" H: 81" - 85"	●	●
Oversize Plus Custom¹ Specify hinge side as viewed from outside.			
370-79 10" x 17" Pet Door	W: 36-1/8" - 42" H: 85-1/8" - 96"	●	
370-78 14" x 23" Pet Door		●	



Standard Venting



Easy Left- or Right-Hinge Installation

10 YEAR
LIMITED WARRANTY



French Door Kit Available
Refer to charts on pages 42-45.

CUSTOM DOORS

- Pet door remains the same size on all custom doors.
- Glass insert size remains standard; frame size adjusts for custom order.
- Maximum size: 42" x 96" uses same size glass insert as standard 36" x 81".
- Minimum size: 28" x 71-1/2" uses same size glass insert as 32" x 81" door.





360-16 / 660-16 Classic-View Reversa Screen / Larson 25 Midview

TOP BENEFITS



Flexible ventilation. Let fresh air flow through the top or bottom window with the Reversa Screen.



Low-maintenance durability. The durable aluminum frame and heavy-duty weatherstrip provide complete entry protection.

ADDITIONAL FEATURES

- Standard Closer
- Steel Kick Panel
- Color-Matched Handleset with Inside Lock
- Door Thickness: 1-1/4"



White Model



Brown Model

FRAME COLORS

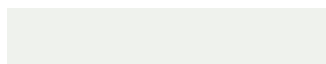

White



Brown

CONFIGURATION AVAILABILITY

MODEL	SIZE	WHITE	BROWN
360-16 (660-16)	32" x 81" 36" x 81"	●	●
	34" x 81"	●	
	30" x 81"	●	●



Reversa Screen



Easy Left- or Right-Hinge Installation





French Door Kit Available

Refer to charts on pages 42-45.



370-50 Life-Core® Reversa Screen / Larson 20+ Midview

TOP BENEFITS

-  **Flexible ventilation.** Let fresh air flow through the top or bottom window with the tear-resistant WearTuff® Reversa Screen.
-  **A full extension.** Built for heavy wear and tear with a hinge and closer system to protect against damage from overextension.
-  **Seal out the elements.** The low-maintenance composite surface and heavy-duty weatherstrip deliver weather-resistant protection.

ADDITIONAL FEATURES

- Solid Wood Core
- Color-Matched Handleset with Keyed Lock
- Door Thickness: 1"



White Model Brown Model

FRAME COLORS

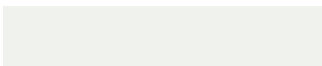

White



Brown

CONFIGURATION AVAILABILITY

MODEL	SIZE	WHITE	BROWN
370-50	32" x 81"	●	●
	34" x 81"	●	●
	36" x 81"	●	●
	30" x 81"	●	●



WearTuff. Reversa Screen



Easy Left- or Right-Hinge Installation



French Door Kit Available
Refer to charts on pages 42–45.



278-SS Life-Core® Single-Vent / Larson 20 Highview

TOP BENEFITS



Open to fresh air. Welcome in fresh air through the built-in bottom screen.



Seal out the elements. The low-maintenance composite surface and heavy-duty weatherstrip deliver weather-resistant protection.

ADDITIONAL FEATURES

- Standard Closer
- Solid Wood Core
- Color-Matched Handleset with Inside Lock
- Door Thickness: 1"



White Model



Almond Model



Sandstone Model



Brown Model

FRAME COLORS

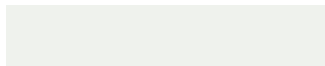

White

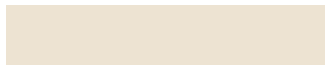

Almond



Sandstone



Brown

CUSTOM DOORS

- Oversize custom: Any dimension larger than 36" wide or 85" high.
- Maximum size: 42" x 85" uses same size glass insert as standard 36" x 81".
- Minimum size: 28" x 52" uses same size glass insert as standard 32" x 81".
- **SPECIAL STANDARD** 32" x 85", 36" x 85" and custom doors over 85" high use a taller glass insert. Standard glass frame sizes are used for all custom doors. The door frame adjusts to fit the custom dimensions.

CONFIGURATION AVAILABILITY

MODEL	SIZE	WHITE	ALMOND	SANDSTONE	BROWN
278-SS	32" x 81" 36" x 81"	●	●	●	●
	30" x 81" 34" x 81"	●			
	32" x 85" 36" x 85"	●			
Regular Custom¹					
278-SS	W: 28" - 36" H: 52" - 85"	●	●	●	●
Oversize Custom¹					
278-SS	W: 36-1/8" - 42" H: 52" - 85"	●			●
Oversize Plus Custom¹ Specify hinge side as viewed from outside.					
278-SS	W: 32" - 42" H: 85-1/8" - 96"	●			●



Standard Venting



Easy Left- or Right-Hinge Installation



10 YEAR LIMITED WARRANTY



French Door Kit Available

Refer to charts on pages 42-45.

¹Custom doors have extended, variable lead times. Once placed, custom orders cannot be canceled.

Note: Larson reserves the right to alter or discontinue any model, specification, warranty or price without notice. Product finish colors are approximate; actual finish colors may vary. See your Larson seller or visit larsondoors.com for details on limited warranties and exclusions.



380-05 Mobile Home Single-Vent / Larson 20 Mobile Midview

TOP BENEFITS



Open to fresh air. Welcome in fresh air through the built-in bottom screen.



Seal out the elements. The low-maintenance composite surface and heavy-duty weatherstrip deliver weather-resistant protection.

ADDITIONAL FEATURES

- Standard Closer
- Solid Wood Core
- Color-Matched Handleset
- Door Thickness: 1"



FRAME COLORS



White

CONFIGURATION AVAILABILITY

MODEL	SIZE	WHITE
380-05	30" x 75" 32" x 75"	●
	30" x 74" 30" x 76" 32" x 74" 32" x 76" 32" x 78" 34" x 78" 36" x 74" 36" x 78"	●



Standard Venting



Easy Left- or Right-Hinge Installation



French Door Kit Available
Refer to charts on pages 42-45.





298-SS Life-Core® Composite Surface Single-Vent / Larson 20 Midview

TOP BENEFITS



Open to fresh air. Easily open the built-in screen thanks to pinch-free ergonomic finger tabs.



Seal out the elements. The low-maintenance composite surface and heavy-duty weatherstrip deliver weather-resistant protection.

ADDITIONAL FEATURES

- Standard Closer
- Solid Wood Core
- Color-Complementing Handleset¹
- Door Thickness: 1"



White Model



Brown Model¹

FRAME COLORS



White



Brown

CONFIGURATION AVAILABILITY

MODEL	SIZE	WHITE	BROWN
298-SS	32" x 81" 34" x 81" 36" x 81"	●	●
	30" x 81"	●	●



Standard Venting



Easy Left- or Right-Hinge Installation

10 YEAR
LIMITED WARRANTY



French Door Kit Available
Refer to charts on pages 42–45.

¹Brown model comes with black handleset and closer.

²Universal hinging is available for most door models, but varies for custom and oversized custom doors. For more information, please contact Larson customer service at 1-800-334-1328.

Note: Larson reserves the right to alter or discontinue any model, specification, warranty or price without notice. Product finish colors are approximate; actual finish colors may vary. See your Larson seller or visit larsondoors.com for details on limited warranties and exclusions.

Measuring Guide

STORM DOORS

Use the diagram below to record your measurements as shown.

If the width measurements vary, record the smallest measurement.

For Platinum Collection installation, please see page 18.

RECESS MOUNT

The rails mount inside the opening and require a 1" wide by 1" deep mounting surface.

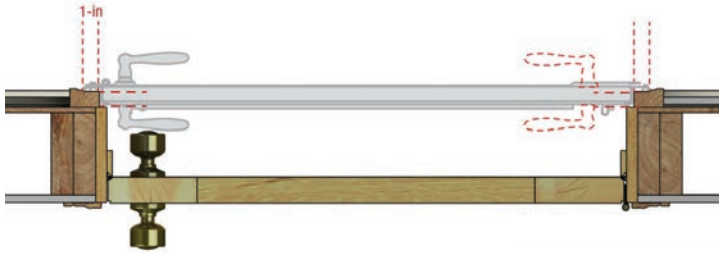

Construction styles may vary.

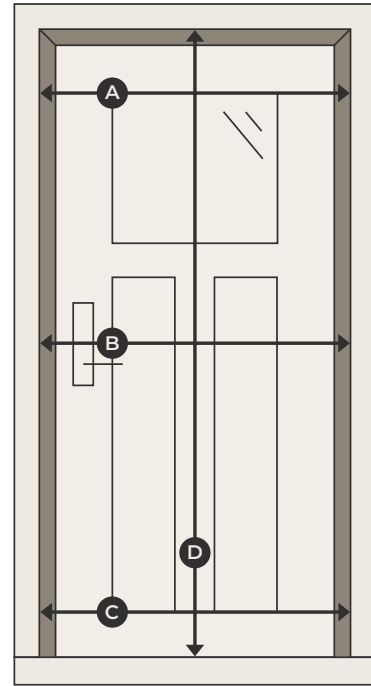

Storm Doors



UNIVERSAL HINGING

Allows for left-hinge or right-hinge installation.²

RECORD MEASUREMENTS

A	Width	C	Width
B	Width	D	Height

SPECIFY WHEN ORDERING

- A.** Model Number
- B.** Color
- C.** Required Opening Size (Width x Height)
- D.** Universal Hinge²

DOOR OPENING	MIN. WIDTH	MAX. WIDTH	MIN. HEIGHT	MAX. HEIGHT
30" x 81"	29-7/8"	30-3/8"	80"	81"
32" x 81"	31-7/8"	32-3/8"		
34" x 81"	33-7/8"	34-3/8"		
36" x 81"	35-7/8"	36-3/8"		
32" x 85"	31-7/8"	32-3/8"	84"	85"
34" x 85"	33-7/8"	34-3/8"		
36" x 85"	35-7/8"	36-3/8"		
32" x 75"	31-7/8"	32-3/8"	74-1/2"	75-1/2"
30" x 75"	29-7/8"	30-3/8"		

French Door Opening Size Availability

NOMINAL SIZE (Width of Two Standard Doors)	FITS OPENING WIDTH		FITS OPENING HEIGHT	
	MINIMUM	MAXIMUM	MINIMUM	MAXIMUM
146 Easy Vent Selection Combination Door Conversion Kit				
32" (2'8" and 2'8")	63-3/4"	64"	80"	81"
36" (3'0" and 3'0")	71-3/4"	72"		
34" (2'10" and 2'10")	67-3/4"	68"		
View Combination Door Conversion Kit				
32" (2'8" and 2'8")	64"	64-1/4"	80"	81"
36" (3'0" and 3'0")	72"	72-1/4"		
30" (2'6" and 2'6")	60"	60-1/4"		
34" (2'10" and 2'10")	68"	68-1/4"		
Classic-View Combination Door Conversion Kit				
32" (2'8" and 2'8")	63-1/2"	64-1/8"	80"	81"
36" (3'0" and 3'0")	71-1/2"	72-1/8"		
Wood Core Storm Door Conversion Kit				
32" (2'8" and 2'8")	63-1/2"	64-1/8"	80"	81"
36" (3'0" and 3'0")	71-1/2"	72-1/8"		
30" (2'6" and 2'6")	59-1/2"	60-1/8"		
34" (2'10" and 2'10")	67-1/2"	68-1/8"		

French Door Kits

CONFIGURATION AVAILABILITY

MODEL	FINISH	PART #
Non-Keyed Mirrored Handles¹ 830-80, 830-82, 691-55, 691-52, 691-90, 278-SS, 370-78, 370-79	White	20266003
	Almond	20266008
	Sandstone	20266009
	Brown	20266004
	Brass	20266007
	Brushed Nickel	20266017
	Aged Bronze	20266057

¹Accepts mirrored handlesets. Must be ordered separately; includes shipping fee.

²Custom sizes: Specify hinge side of main operating door as viewed from the outside.

Note: Larson reserves the right to alter or discontinue any model, specification, warranty or price without notice. Product finish colors are approximate; actual finish colors may vary.

French Door Conversion Kits

Order by part number.

MODEL	SIZE	PART NUMBER					
		WHITE	ALMOND	SANDSTONE	BROWN	GRAPHITE	BLACK
Easy Vent Selection 146FVE 146MV 146FV 146HV 146BV 146PV	60" x 80"	080031033RF					
	64" x 80"	080031031RF	080031081RF	080031091RF	080031041RF	080031391RF	080031051RF
	68" x 80"	080031035RF		080031095RF			
	72" x 80"	080031032RF	080031082RF	080031092RF	080031042RF	080031392RF	080031052RF
146FVE 146FV	Custom Sizes ²	Included in door product ID.					Included in door product ID.
150 Maximum View 150FX 150FXE 150BX	60" x 80"	08007033RF					
	64" x 80"	08007031RF	08007081RF	08007091RF	08007041RF	08007391RF	08007051RF
	68" x 80"	08007035RF					
	72" x 80"	08007032RF	08007082RF	08007092RF	08007042RF	08007392RF	08007052RF
150FX 150FXE 150FXN 150FXEB 150FXB 150FXNB	Custom Sizes ²	Included in door product ID.					Included in door product ID.
1-1/4" Thick 350 350-04 350-17	64" x 80"	08020361RF	08020861RF	08020961RF	08020461RF		08020561RF
	72" x 80"	08020362RF	08020862RF	08020962RF	08020462RF		08020562RF
Classic-View 360-16 660-16 360-48	60" x 80"	080103033RF			080103043RF		
	64" x 80"	080103031RF		080103091RF	080103041RF		
	68" x 80"	080103035RF					
	72" x 80"	080103032RF		080103092RF	080103042RF		
360-48	Custom Sizes ²	Included in door product ID.			Included in door product ID.		
830 Lifestyle¹ 830-80 830-82 830-85	64" x 80"	08003061RF	08008061RF	08009061RF	08004061RF		
	72" x 80"	08003062RF	08008062RF	08009062RF	08004062RF		
691 Lifestyle¹ 691-52 691-90 691-55	64" x 80"	08003061RF	08008061RF	08009061RF	08004061RF		
	72" x 80"	08003062RF	08008062RF	08009062RF	08004062RF		
830 830-80 830-82 830-85	Custom Sizes ²	Included in door product ID.					
691 691-52 691-90 691-55	Custom Sizes ²	Included in door product ID.					

French Door Kits

French Door Conversion Kits *continued*

Order by part number.

MODEL	SIZE	PART NUMBER			
		WHITE	ALMOND	SANDSTONE	BROWN
Life-Core¹ 278-SS 370-79 370-78 LifeStyle 370-84*	60" x 80"	08003053RF			
	64" x 80"	08003051RF	08008051RF	08009051RF	08004051RF
	72" x 80"	08003052RF	08008052RF	08009052RF	08004052RF
	64" x 85"	08003054RF			
	68" x 80"	08003055RF	08008055RF	08009055RF	08004055RF
	72" x 85"	08003057RF			
	Custom Sizes ²	Included in door product ID.			
298-SS 370-50	60" x 80"	08003003RF	08008003RF		08004003RF
	64" x 80"	08003001RF	08008001RF		08004001RF
	68" x 80"	08003005RF			08004005RF
	72" x 80"	08003002RF	08008002RF		08004002RF
380-05	60" x 74" 60" x 75" 60" x 76"	08003003RF			
	64" x 74" 64" x 75" 64" x 76" 64" x 78"	08003001RF			
	68" x 78"	08003005RF			
	72" x 74" 72" x 78"	08003002RF			

French Door Kits

¹Accepts mirrored handlesets. Must be ordered separately; includes shipping fee.

²Custom sizes: Specify hinge side of main operating door as viewed from the outside.

*370-84 is not available in Sandstone or custom sizes.

Note: Larson reserves the right to alter or discontinue any model, specification, warranty or price without notice. Product finish colors are approximate; actual finish colors may vary.

Measuring Guide

EXISTING FRENCH DOOR OPENING

1. Measure full width of opening from jamb exterior trim where storm doors will attach to the trim.
2. Measure full height of opening from head exterior trim to threshold where storm doors will attach.
3. Compare your dimensions with the standard French storm door opening size guide. If your opening does not match a standard, you need custom French doors.

Note: Continuous wood shims up to 1/4" thick can be installed behind both hinge mounting rails, allowing a given width of standard doors to fit an opening 1/2" wider. Extra long screws will be needed to secure.

1 Front View

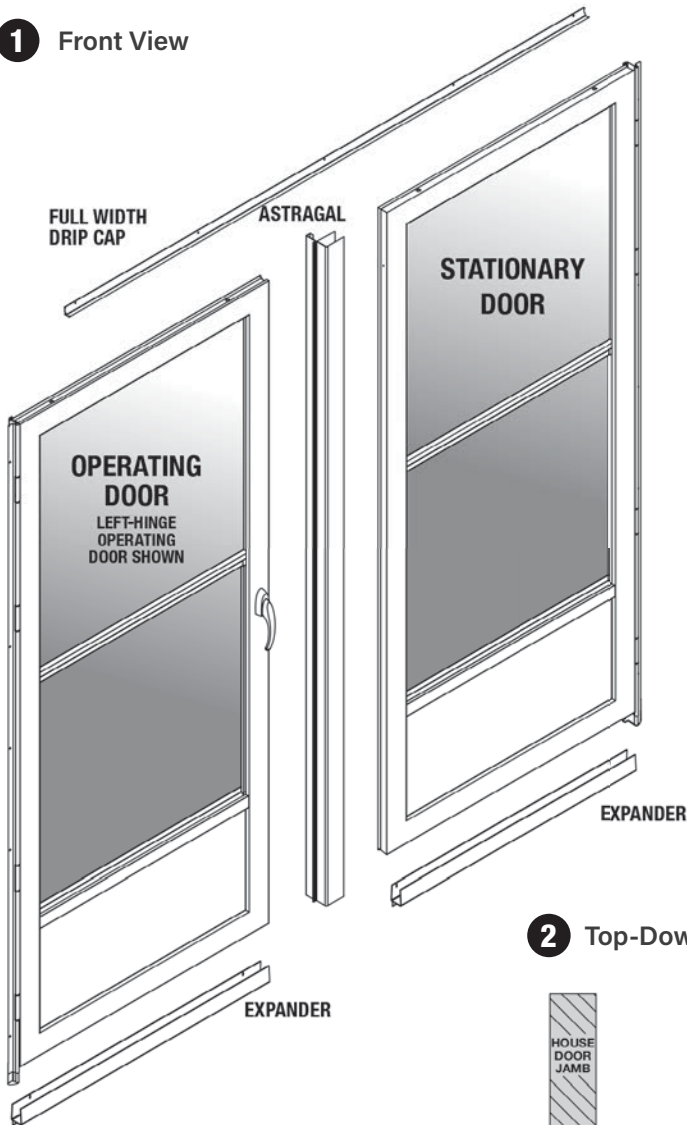

With a French door installation, you will have one left-hinge door and one right-hinge door. The astragal included in your French door kit replaces the latch side mounting rail included with each door. The full width drip cap included in the French door kit replaces the top drip caps included with the doors.

See pages 42–44 for size range per series.

ORDERING FRENCH DOOR UNITS

Standard Sizes: Order two standard size doors and a standard size French door kit.

Custom Sizes: Measure the true opening size of the entry and order the doors as **one** custom French door configuration with that measurement in inches (For example, 73" x 84"). Use the same measurement to order a French door kit separately.

TYPICAL LARSON® STORM DOOR FRENCH DOOR INSTALLATION

Kit parts, instructions and astragal vary by model.

2 Top-Down View

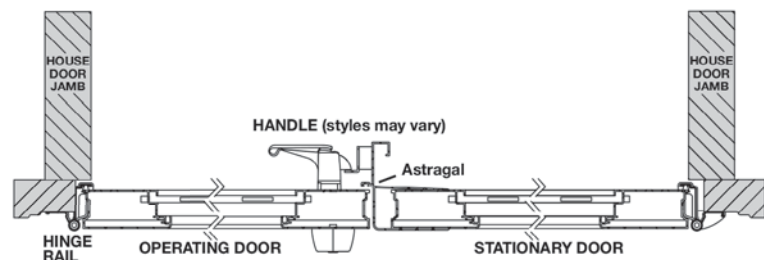

FRENCH DOOR KIT

With our French door conversion kits, Larson storm doors are easily adapted for double door entry applications. Each kit includes detailed installation instructions, all necessary hardware, an astragal and a special drip cap. Refer to French door size guide for proper selection of French door conversion kits. **Inactive handleset available on select models (sold separately).**

Security Storm Doors

Guardsman Collection

BE READY FOR LIFE WITH LARSON

The Guardsman Collection offers a complete line of steel security doors engineered to protect what matters most without sacrificing style and ease of use.



Welded-steel frame safeguards entry with industrial-grade protection.



Tempered safety glass protects entry from weather.



Seven-inch reinforced hinges provide a secure mount.



Anti-removal vault pin is shielded within door to resist tampering.





Guardisman Collection

LIMITED LIFETIME
5 YEAR WARRANTY

FRAME COLORS



White



Sandstone



Brown



Graphite



Black

AVAILABLE MODELS

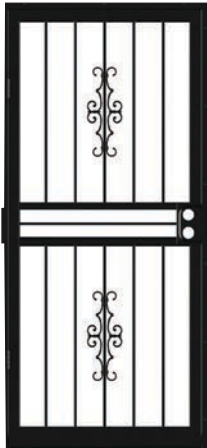

Courtyard
920-20



Garden View
920-21



Geneva
920-24



El Dorado
920-28

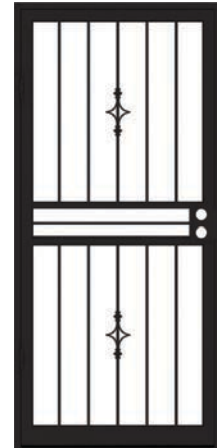

SoHo
920-36

Security Storm Doors



¹Custom doors have extended, variable lead times. Once placed, custom orders cannot be canceled.

Note: Larson reserves the right to alter or discontinue any model, specification, warranty or price without notice. Product finish colors are approximate; actual finish colors may vary. See your Larson seller or visit larsondoors.com for details on limited warranties and exclusions.

CONFIGURATION AVAILABILITY

MODEL	SIZE	WHITE	BLACK	SANDSTONE	BROWN	GRAPHITE
Courtyard 920-20	32" x 81" 36" x 81"	●	●	●	●	●
Garden View 920-21		●	●	●	●	●
Geneva 920-24		●	●	●	●	●
El Dorado 920-28		●	●	●	●	●
SoHo 920-36		●	●	●	●	●

Thickness: 1"

SINGLE CUSTOM¹

MODEL	SIZE		
	REGULAR CUSTOM W: 30" - 36" H: 76" - 84"	OVERSIZE CUSTOM W: 36-1/8" - 42" H: 76" - 84"	OVERSIZE PLUS CUSTOM W: 30" - 42" H: 84-1/8" - 96"
Courtyard 920-20	●	●	●
Garden View 920-21	●	●	●
Geneva 920-24	●	●	●
El Dorado 920-28	●	●	●
SoHo 920-36	●	●	●

DOUBLE CUSTOM¹

Courtyard 920-20	●	●	●
Garden View 920-21	●	●	●
Geneva 920-24	●	●	●
El Dorado 920-28	●	●	●
SoHo 920-36	●	●	●

TOO MANY KEYS?

Provide your own hardware so you can open your entry and security doors with the same key.

Select standard entry door hardware with a 2-3/8" backset and a 2-1/8" hole diameter.



Lock Box Location



STANDARD

Hardware location for Guardsman doors are figured from the top of the opening down to the center of the lever / knob, which is mounted in the top hole of the lock box. Based on a standard 81" door, this measurement is 38".

CUSTOM

When ordering, indicate the distance from the top of the door opening to the center of the lock box.

Allowable location is center of the door based on the centered ordered opening height + or - 12".

Example: Opening Height: 83"
 Center of Door: 41-1/2"

Maximum Height: 53-1/2" (41-1/2" + 12" = 53-1/2")

Minimum Height: 29-1/2" (41-1/2" - 12" = 29-1/2")

ACCESSORY ADD-ONS¹

PRODUCT OPTIONS	FRAME COLORS & SIZES
Custom Lock Box Heights Provide measurements when ordering - see above.	Order Custom Sizes
Mail Slot - Silver or Brass Finish Double Doors: Mail slot installed on active door.	Order Custom Sizes
Insect Screen Half screen fits top or bottom for standard door sizes only.	White, Black - Standard Sizes only (Single Door)
	All Colors - Custom Sizes (Single Door)
	Double Door - 2 Screens

¹Door Options (excluding half screen) are non-retrofitable and must be ordered with the door.

²Hinge side specification required for custom doors only.

Note: Larson reserves the right to alter or discontinue any model, specification, warranty or price without notice. Product finish colors are approximate; actual finish colors may vary. See your Larson seller or visit larsondoors.com for details on limited warranties and exclusions.

How to Measure for a Security Door

Measure the opening width (horizontally).
 Take three measurements, one across the top (A), middle (B) and bottom (C) of the door. Record the narrowest dimension.
 Measure the vertical opening height (D).

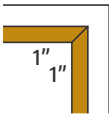
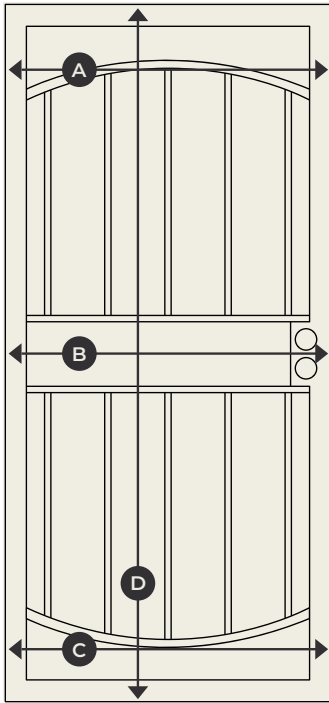

1" x 1" Deep Mounting Surface is Required



Universal Hinging

YOUR WIDTH MEASUREMENT	YOUR HEIGHT MEASUREMENT	DOOR SIZE YOU NEED
29-7/8" – 30-3/8"	80" – 81"	30" x 80" – 81"
31-7/8" – 32-3/8"		32" x 80" – 81"
33-7/8" – 34-3/8"		34" x 80" – 81"
35-7/8" – 36-3/8"		36" x 80" – 81"
31-7/8" – 32-3/8"	74-1/2" – 75-1/2"	32" x 74-1/2" – 75-1/2"
29-7/8" – 30-3/8"		30" x 74-1/2" – 75-1/2"
31-7/8" – 32-3/8"	95-1/2" – 96-1/2"	32" x 95-1/2" – 96-1/2"
35-7/8" – 36-3/8"		36" x 95-1/2" – 96-1/2"

SPECIFY WHEN ORDERING

- A. Model Number
- B. Color
- C. Required Opening Size (Width x Height)
- D. Hinge Side (LH or RH)²

STANDARD DOOR WIDTH	OPENING WIDTH RANGE	OPENING HEIGHT RANGE
32"	31-7/8" – 32-3/8"	79-3/4" to 81"
36"	35-7/8" – 36-3/8"	

Security Round Top Styles

Guardisman Collection

The Guardsman Collection features two styles in a round top configuration. These doors feature tempered safety glass and include a pneumatic closer and wind chain. Unlike standard security doors, round top doors require more complex installation; professional installation is recommended.

Delivery: Expect extended lead times from the day the order is placed and template is approved.

Installation: Framing includes three pieces and requires a professional installation for on-site adjustments.

FRAME COLORS



White



Sandstone



Brown



Graphite



Black



Fullview Model

PRODUCT FEATURES

- Fixed glass panel.
- Mortise-style lock included.
- Width: 30" - 42", Height: 76" - 96"



Double key lock cylinder standard.
Thumb turn key optional with Brass and Antique Brass. Specify when ordering.



Brushed Nickel



Aged Bronze



Brass



Antique Brass

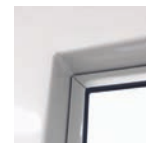

Exterior



Interior

Courtyard Model

PRODUCT FEATURES

- Security bars with 3 fixed glass panels.
- Reinforced lock box.
- Bottom insect screen sold separately.
- Width: 30" - 42", Height: 76" - 96"



TOO MANY KEYS?

Provide your own hardware so you can open your entry and security doors with the same key.

Select standard entry door hardware with a 2-3/8" backset and a 2-1/8" hole diameter.

Measuring Guide

ROUND TOP GUIDELINES

For pricing, complete this form and email to quotes@larsondoors.com or FAX to 800-888-9006.

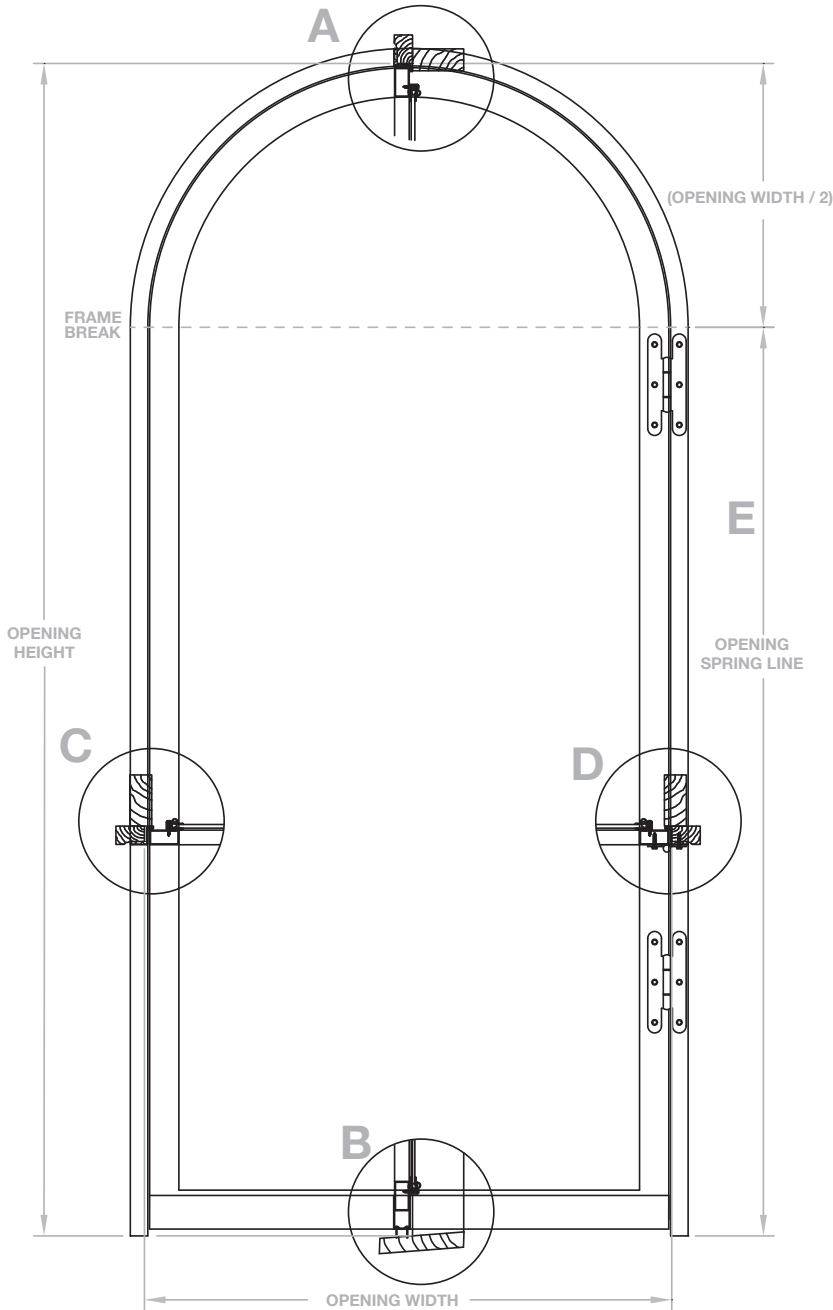

NOTES: _____

1. Hinging:

as viewed from outside

Left-Hinge

Right-Hinge

2. Rough Opening Height (A/B):

3. Rough Opening Width (C/D):

4. Rough Opening Spring Line (E):

A squared 1" x 1" brickmould is required for installation. Any shape other than a true half round will require an opening template.

DEALER _____
 CONTACT _____
 ADDRESS _____

 EMAIL _____

Note: Larson reserves the right to alter or discontinue any model, specification, warranty or price without notice. Product finish colors are approximate; actual finish colors may vary.

Retractable Screen Products

SCREENS FOR YOUR WHOLE HOME

Larson® screen products are designed to fit most existing door or window applications for the patio, lanai, garage, gazebo and front door. In addition to providing instant ventilation, retractable screens offer protection from airborne pests and harsh UV rays.

RETRACTABLE SCREEN BENEFITS

Choose from a complete line of screens, which includes options for single door openings as well as large openings up to 378" (31-1/2') wide. More configuration details can be found on page 69. Available in trending colors and styles to complement your home.

- Protection from airborne, biting pests.
- Easy to install and operate.
- Smooth operation with controlled retraction.
- Supports fresh, natural ventilation.

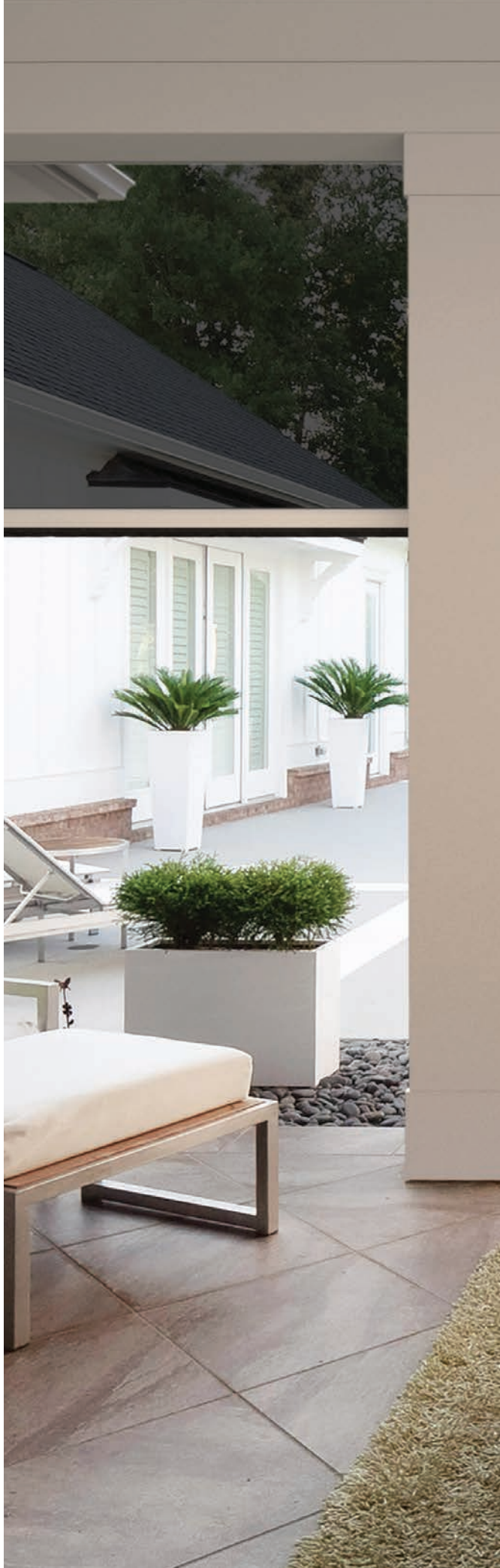



Find the Right Screen

Use this guide to find the retractable screen that fits your opening and meets your overall needs. Once you have narrowed down your selection, go to each product page for complete details.

OPENING TYPE	MODEL	SIZING	INSTALLATION TYPE	
RETRACTABLE SCREEN DOOR - SINGLE & DOUBLE				
Single Hinged Door	Brisa 7721	Standard Sizes: Fits most traditional 6'6", 6'8" and 8'0" high entries up to 36" wide.	Surface / Face Mount	
	Escape E100	Custom Sizes: Up to 60"w x 96"h.	Surface / Face Mount Recess / Inset Mount	
	Inspire	Custom Sizes: Up to 63"w x 125"h.	Recess / Inset Mount	
Double Hinged Doors	Brisa 7722	Standard Sizes: Fits most traditional 6'6", 6'8" and 8'0" high entries up to 72" wide.	Surface / Face Mount	
	Escape E200	Custom Sizes: Up to 96"w x 96"h.	Surface / Face Mount Recess / Inset Mount	
	Inspire	Custom Sizes: Up to 126"w x 125"h.	Recess / Inset Mount	
Sliding Patio Door	Brisa 7723*	Standard Size: Fits most 6'8" high XO or OX sliding patio doors.	Surface / Face Mount	
RETRACTABLE SCREEN DOOR - MULTI-PANEL				
Multi-Panel Doors	Wall Screen WS1000	Custom Sizes: Up to 177"w x 118"h. Maximum opening size of 114-3/5 sq. ft.	Recess / Inset Mount	
	Wall Screen WS2000	Custom Sizes: Up to 315"w x 118"h. Maximum opening size of 229-1/5 sq. ft.	Recess / Inset Mount	
	Inspire	Custom Sizes: Up to 378"w x 125"h.	Recess / Inset Mount	
RETRACTABLE WINDOW				
Casement, Awning Slider & Others	NatureVue NV100	Custom Sizes: 72"w x 90"h.	Surface / Face Mount Recess / Inset Mount	
RETRACTABLE MOTORIZED SCREEN				
Porch, Patio, Gazebo, Outdoor Living Area	Retractable Motorized Screen 6+, 7+, 8+, 9+, 10+	Custom Sizes: Up to 240"w x 144"h, depending on screen type.	Surface / Face Mount Recess / Inset Mount	

¹Based on average DIY skills and standard door application, widths 32"-36" (single), 68"-72" (double).
*Brisa Slider is the recommended way to screen most standard 6'8" high XO or OX sliding patio doors.

	FABRIC TYPE	FEATURES
	Smooth	EZ-Glide System ■ 30-Minute Install ¹ ■ Mechanical Latch & Lock
	Smooth	Slam-Proof Retraction ■ Worry-Free Ventilation ■ Magnetic Latch
	Pleated	Flat Bottom Guide ■ Anywhere Positioning ■ Magnetic Latch
	Smooth	EZ-Glide System ■ 30-Minute Install ¹ ■ Mechanical Latch & Lock
	Smooth	Slam-Proof Retraction ■ Worry-Free Ventilation ■ Magnetic Latch
	Pleated	Flat Bottom Guide ■ Anywhere Positioning ■ Magnetic Latch
	Smooth	EZ-Glide System ■ 30-Minute Install ¹ ■ Mechanical Latch & Lock
	Pleated	One-hand Operation ■ Anywhere Positioning ■ Mechanical Latch
	Pleated	One-hand Operation ■ Anywhere Positioning ■ Mechanical Latch
	Pleated	Flat Bottom Guide ■ Anywhere Positioning ■ Magnetic Latch
	Smooth	Controlled Retraction ■ Thick Insect Pile ■ Metal Handle
	Smooth	Remote and Automated Operation ■ Insect, Solar and Privacy, and Vinyl Options ■ Durable Construction



Brisa Retractable Screen Door

7721 (Single) 7722 (Double) 7723 (Slider)

A FRESH APPROACH TO FRESH AIR

Open your home to a new world of fresh air and light with the Brisa retractable screen door that pairs smart, contemporary design with smooth operation.

TOP BENEFITS



Worry-free ventilation. Screen provides bug-free air when you need it and retracts out of sight when you don't.



Smooth operation. The EZ-Glide System and ergonomic handle work together for easy one-hand operation.



30-minute install.¹ Surface mount installation works for right- or left-hand operation.

ADDITIONAL FEATURES

- Durable rust-resistant aluminum housing and track provide long-term reliability.
- Subtle stripes prevent walk-throughs.
- Quick-snap track requires no cutting for standard size openings.

FRAME COLORS

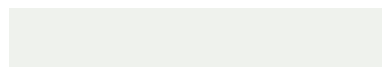

White



Sandstone



Brown



Black

LIFETIME
LIMITED WARRANTY

CONFIGURATIONS

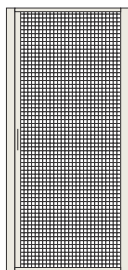

7721 Single

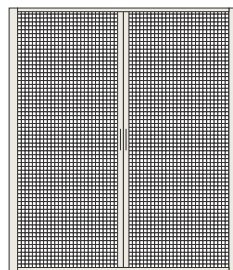

7722 Double

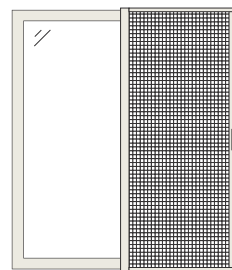

7723 Slider

¹Based on average DIY skills and standard door application, widths 32"-36" (single), 68"-72" (double).

*The Brisa retractable door screen is a face (surface) mounted product.

**The Brisa retractable door screen for sliding patio doors has been specifically designed and sized to mount on a typical 6'8" tall sliding patio door.

Note: See your Larson seller or visit larsondoors.com for details on limited warranties and exclusions. Not intended to keep children or pets inside. Product finish colors are approximate; actual finish colors may vary.

CONFIGURATION AVAILABILITY

BRISA - SINGLE PACK							
MODEL		OPENING WIDTH	OPENING HEIGHT	WHITE	SANDSTONE	BROWN	BLACK
Brisa 7721* Single Door	Short	32" - 36"	78" - 79" (e.g. 6'6" doors)	●	●	●	●
	Standard	32" - 36"	80" - 81" (e.g. 6'8" doors)	●	●	●	●
	Tall	32" - 36"	96" - 97" (e.g. 8'0" doors)	●	●	●	●
Brisa 7722* Double Door	Short	68" - 72"	78" - 79" (e.g. 6'6" doors)	●	●	●	●
	Standard	68" - 72"	80" - 81" (e.g. 6'8" doors)	●	●	●	●
	Tall	68" - 72"	96" - 97" (e.g. 8'0" doors)	●	●	●	●
Brisa 7723** Sliding Door	Standard	32" - 36"	78" - 79" (e.g. 6'6" doors)	●			

BRISA - 3-PACK					
MODEL		WHITE	SANDSTONE	BROWN	BLACK
Brisa 7771* Single Door	Short	●			
	Standard	●	●	●	●
	Tall	●			
Brisa 7773** Sliding Door	Standard	●			

SPECIFY WHEN ORDERING

- A. Quantity
- B. Product Model Number
- C. Short, Standard, Tall
- D. Frame Color

- Mounts easily on a minimum 1" x 1" surface area.
- No-cut quick-snap track installs easily and adjusts to widths between 32" and 36" for single and sliding door applications, and between 68" and 72" for double doors.

Note: If door is less than 32" wide (single) or 68" wide (double), two simple cuts are required.

Feature Overview

The Brisa retractable screen offers innovative features and smooth operation without compromising on style.

ASSEMBLY

- Simple-to-install quick-snap track means fewer assembly steps and an easier installation experience.
- Speed reducer provides safety and controlled retraction.
- Fits both left- and right-hand inswing and outswing doors with no modification.

SCREEN FABRIC

- Anti-fraying double weave at the top and bottom of the screen fabric.
- Durable screen fabric with subtle safety stripes woven into the fabric provide faint visual cues to help prevent walk-throughs. Top stripes are for people and bottom for pets.

HANDLE

- Ergonomically designed handle with latch and lock offers simple and secure one-hand operation.
- Locking handle.
- Mechanical latch.

STYLES

- Wide range of standard sizes, including 96" high doors.
- Telescoping width adjustment allows the screen to fit a range of opening widths.
- Stock sizes that fit most typical door sizes.
- Available in single door, double door and sliding patio door sizes.



30-minute or less installation.¹

HANDING

Adjusts easily to fit a left- or right-hand application.

SMOOTH GLIDING, NO SLAMMING

Screen retracts all the way without assistance or banging.

SILL PLATE

Aluminum sill plate with adjustable extenders (no gaps, blunt or sharp edges to step on).

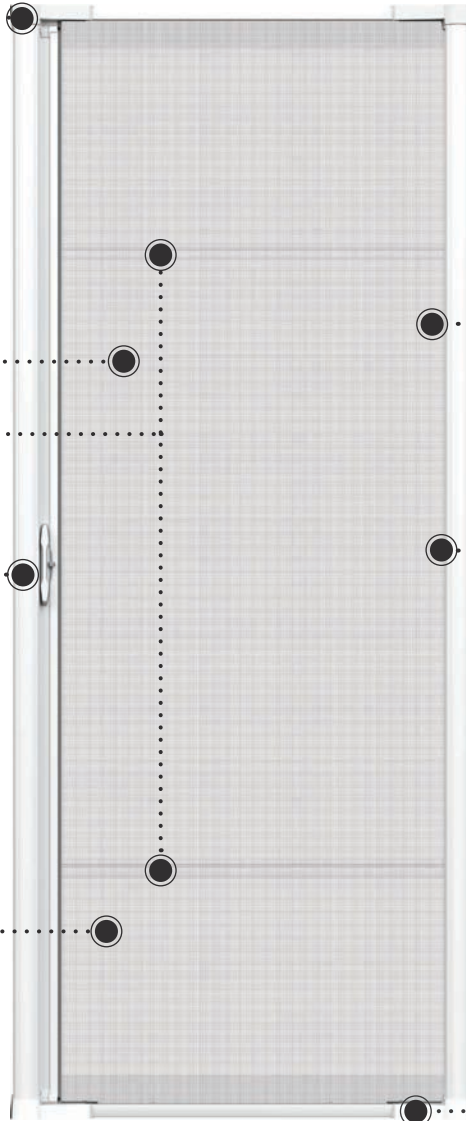

Additional Sizing & Application Detail

Shown below are the size ranges for Brisa single, double and slider options.

The Brisa screen for single- and double-panel hinged doors is surface / face mounted to the front surface of the door brickmould / trim **(see image)**.

Doors, door frames and door sills vary by manufacturer. An advantage of surface mounting the Brisa screen is the ability to position it up or down in the opening to best fit the door frame before fastening in place. This makes the Brisa screen extremely versatile and able to fit multiple opening heights.

6'8" high door heights are the most common; however, heights vary by geographic region. When installing on a single- or double-hinged door, a 3/4" or greater mounting surface depth is required inside the door frame. For 6'8" high sliding patio doors, refer to installation and mounting instructions.

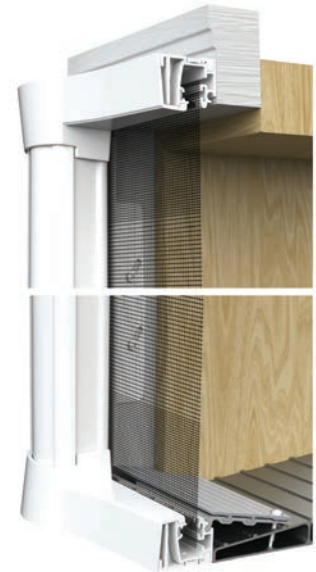

Surface / Face Mounting on a Traditional Hinged Door.

The Brisa retractable screen door is a surface / face mounted product. However, sizing is determined by door opening rather than the intended placement of the Brisa on the exterior door trim or brickmould. Measure for your Brisa by true opening size.

DOOR TYPE	MODEL HEIGHT	FITS OPENING WIDTHS	FITS OPENING HEIGHTS	TIP-TO-TIP HEIGHT DIMENSIONS OF ASSEMBLED SCREEN HOUSING
Single	Short	32"-36"	78"-79" (e.g., 6'6" doors)	79"
Single	Standard	32"-36"	80"-81" (e.g., 6'8" doors)	81-3/8"
Single	Tall	32"-36"	96"-97" (e.g., 8'0" doors)	97-3/8"
Double	Short	68"-72"	78"-79" (e.g., 6'6" doors)	79"
Double	Standard	68"-72"	80"-81" (e.g., 6'8" doors)	81-3/8"
Double	Tall	68"-72"	96"-97" (e.g., 8'0" doors)	97-3/8"
Slider	Standard	32"-36"	78"-79" (e.g., 6'6" doors)	79-1/4"

- Two cuts required if less than 32" for single doors and 68" for double doors.
- Door designs and thresholds vary. It may be possible to position the screen upward or downward to fit an opening size not listed. In such cases, a filler board or trim may be needed. Doors with transoms above the door may also require a filler board or trim before or after installing the screen. Always ensure the bottom of the screen is firmly supported **(see page 62)**.
- The Brisa slider fits most traditional 6'8" tall patio doors and includes different mounting hardware and a slightly shorter screen housing. This allows the system to rest in the opening as needed **(see page 66)**.

Screen Height Position on a Hinged Door

RECOMMENDED INSTALLATION

No filler board should be necessary. The unit can be moved up and down to fit the opening as desired.

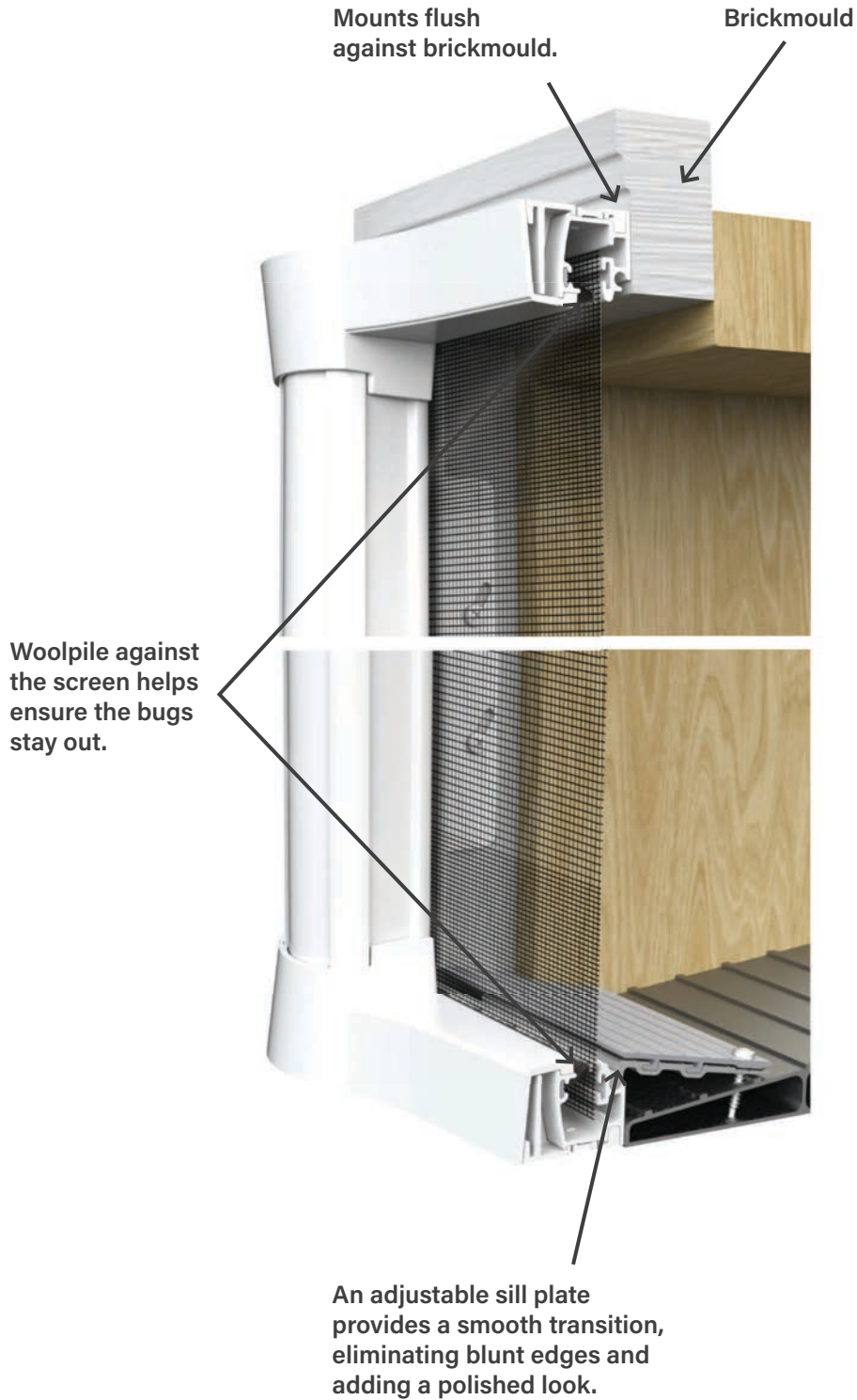

Screens for Single Panel Hinged Doors

Available in three heights — short, standard and tall — to fit most common doors.

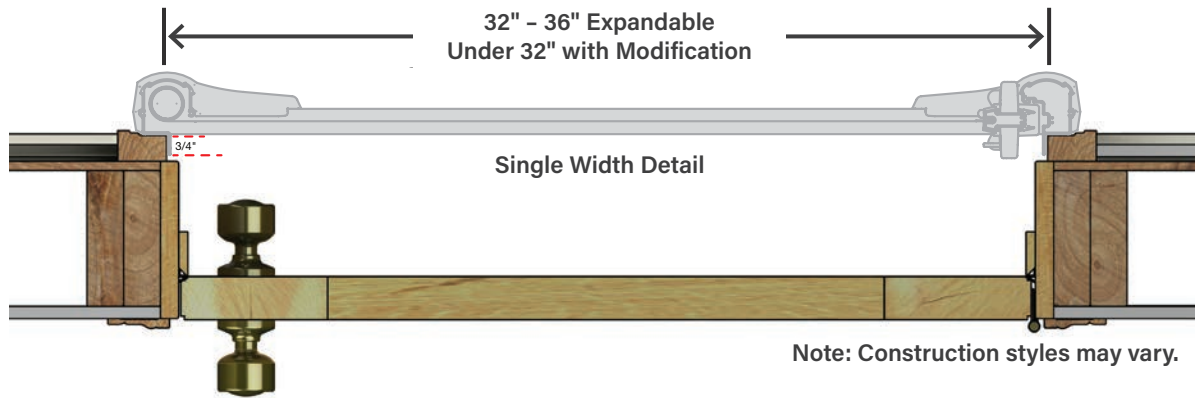

Component Dimensions – Single Screen

A mounting flange is positioned 1-1/16" from the outer edge at the back of the screen housing and decorative housing.

The mounting flange requires this 3/4" depth for mounting to the side brickmould / door trim.

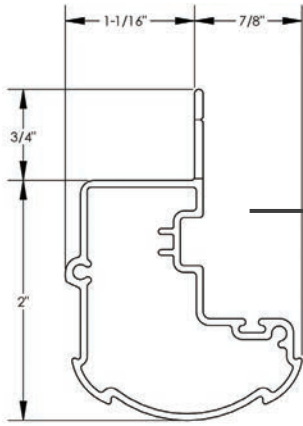

Decorative Housing Profile

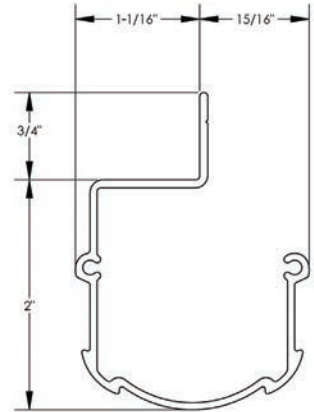

Screen Housing Profile

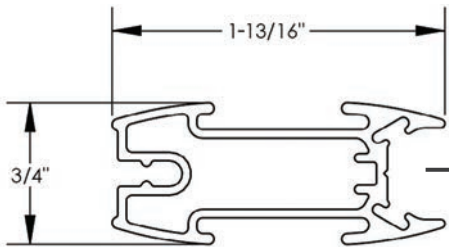

Slider Bar Profile

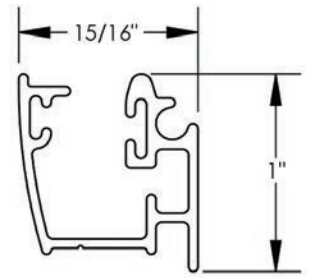

Top Track / Bottom Track

Shown in Locked Position

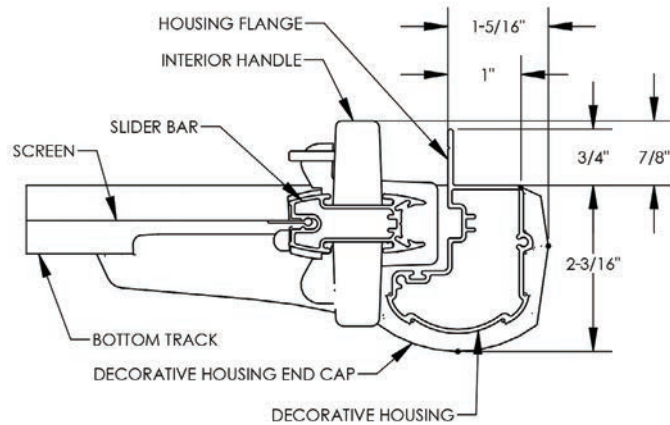

Screens for Double Panel Hinged Doors

Available in three heights — short, standard and tall — to fit most common doors.

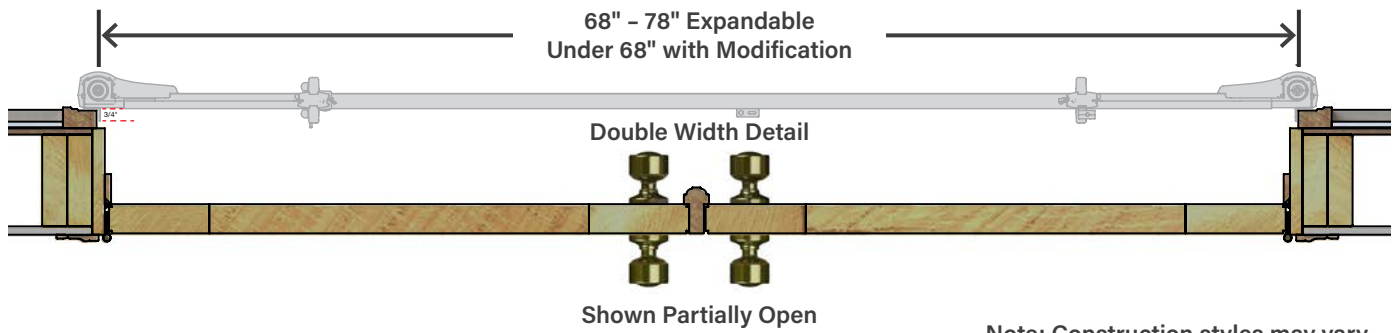

Retractable Screen Products

Brisa for Sliding Patio Doors

The Brisa screen for single sliding patio doors is for use with traditional 6'8" high sliding patio doors. **(Fig. A)** This screen features unique mounting hardware and is specially sized so that the screen housing will rest and secure to the outer door frame. The door frame must have a surface to attach the mounting bracket screws. The distance between these screws is 78-1/2". **(See Fig. C & D)** Please see the following images and visit larsondoors.com/screens/brisa-retractable-screens to view the installation video and instructions.

Retractable Screen Products

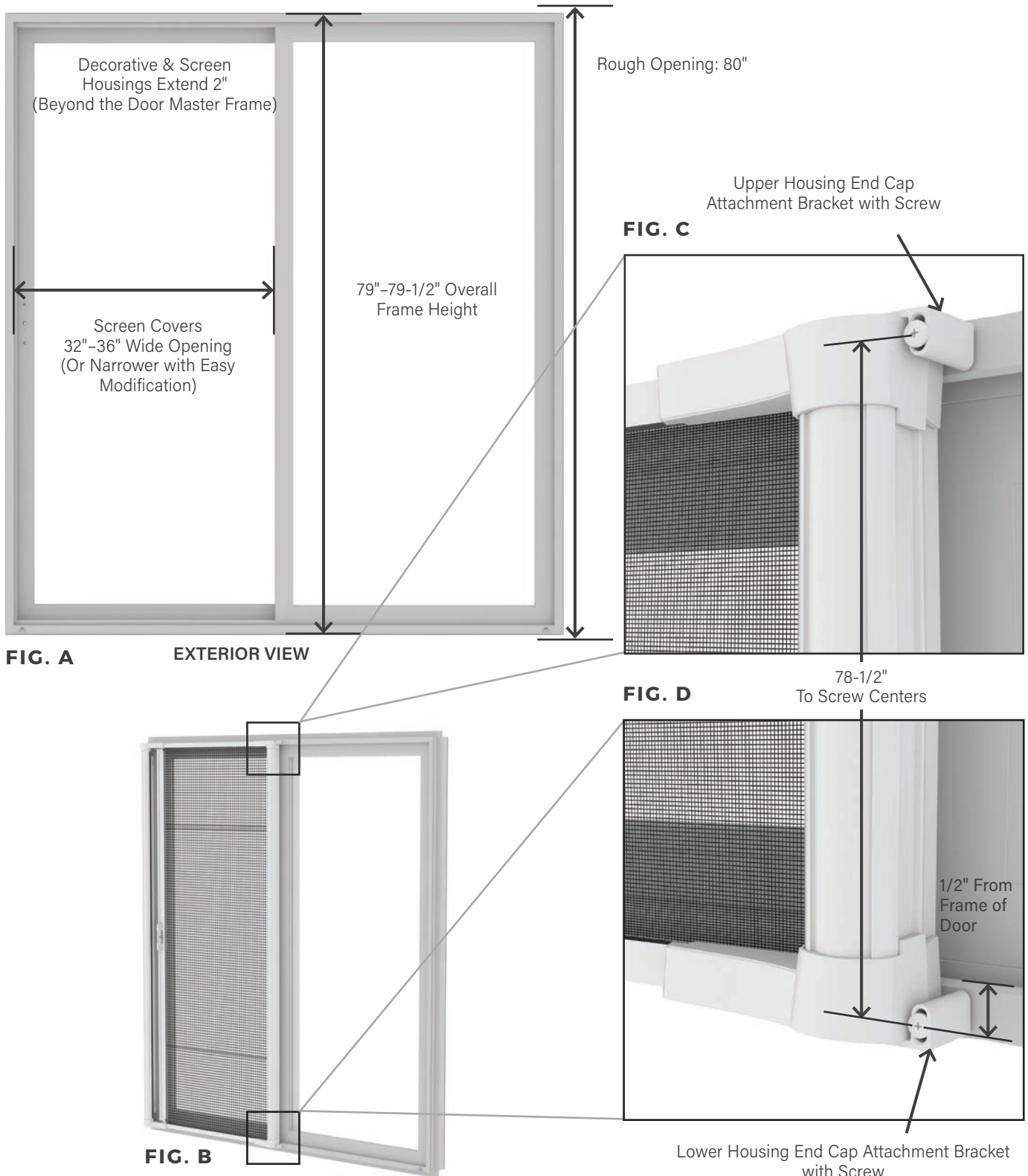



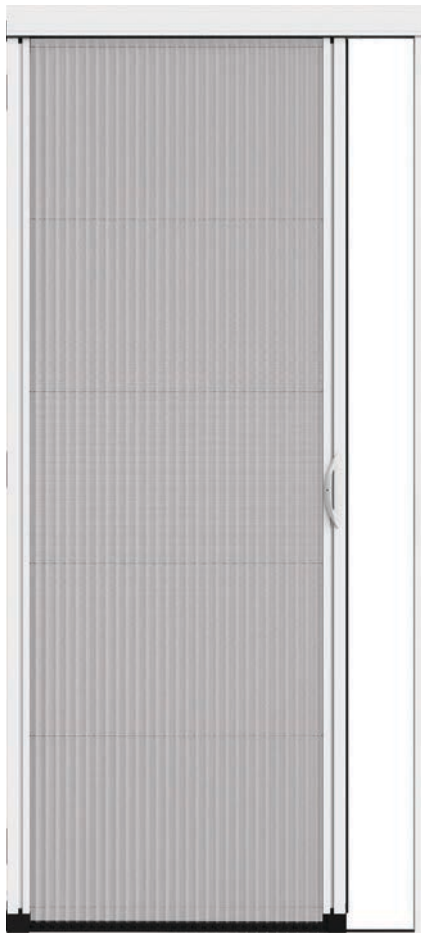



Inspire Pleated Retractable Screen Door

SEAMLESS INDOOR-OUTDOOR LIVING

Create a smooth transition between indoor and outdoor living with the Inspire pleated retractable screen door.

TOP BENEFITS

-  **Fresh style.** Elegant, pleated fabric provides ventilation with refined design.
-  **Unobstructed access.** The flat bottom guide installs without a runner for easy movement through the entry.
-  **Custom-made ventilation.** Designed to fit single and double doors and openings up to 31-1/2' wide and over 10' high.

ADDITIONAL FEATURES

- Easily move and stop the screen at any position with one hand.
- Includes metal adjustable-height handles.
- Pre-assembled for easy installation without any cutting.

FRAME COLORS



White

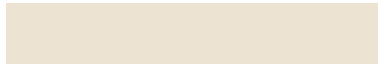

Almond



Desert Tan



Brownstone



Black

5 YEAR

LIMITED WARRANTY

PROFILES

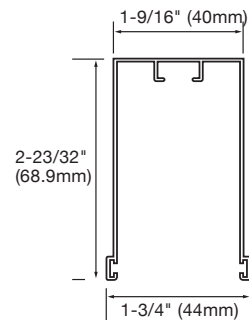

Top Profile

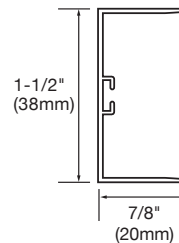

Side Profile

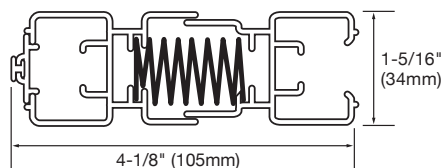

Screen Panel Profiles
with Pleated Fabric

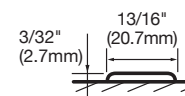

Bottom Guide

OPENING CONFIGURATIONS View from the Outside (Specify Configuration When Ordering)

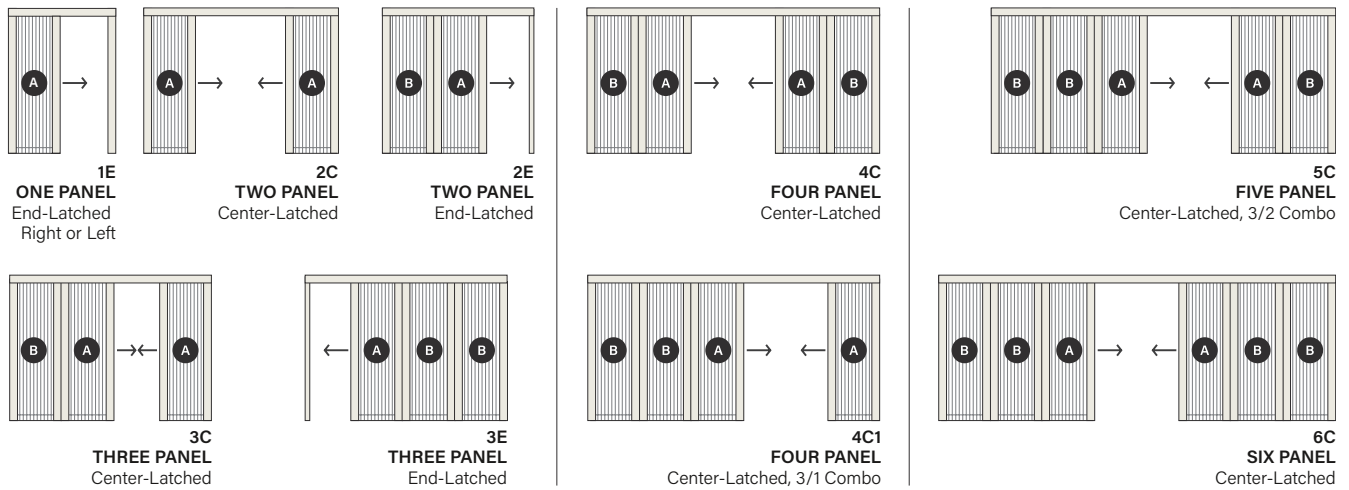

LEGEND **A** End Panel with Seal **B** Panel with Connector

CONFIGURATION AVAILABILITY

INSPIRE IN100 (Custom Sizes)		
FINISH COLOR	WIDTH PER PANEL MIN-MAX	HEIGHT PER PANEL MIN-MAX
White Almond Desert Tan Brownstone Black	up to 63"	22" - 84"
		84-1/8" - 96"
		96-1/8" - 114"
		114-1/8" - 125" For larger openings, call for quote.

SPECIFY WHEN ORDERING

- A.** Quantity
- B.** Product Model
- C.** Frame Color
- D.** Net Screen Opening Size (Width x Height)
- E.** Configuration for Multi-Panel Orders

- When ordering, provide the net finished opening dimension, color, total number of desired screen panels and opening configuration as viewed from outside.
- Panels may be combined to accommodate larger openings but must be ordered using opening configurations as shown (1E - 6C). Maximum number of panels per opening: 3 from right/3 from left = **6 TOTAL PANELS UP TO 31-1/2'**
- Screen panel height must be at least 10" higher than width.
- Custom doors have extended, variable lead times. Once placed, custom orders cannot be canceled. All other orders can be canceled within the first 24 hours.

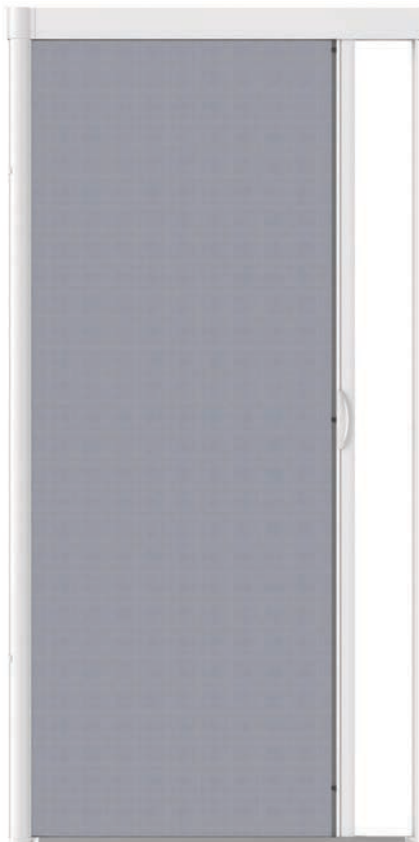

Escape® Retractable Screen Door

Escape E100 (Single) E200 (Double)

AT THE THRESHOLD OF SERENITY

Enjoy the outdoors without interruption using the Escape retractable screen door.

TOP BENEFITS



Worry-free ventilation. Screen provides bug-free air when you need it and retracts out of sight when you don't.



Slam-proof retraction. Controlled retraction prevents the screen from slamming shut.



Custom-made ventilation. Designed to fit single and double doors and openings up to 96" wide and up to 96" high.

ADDITIONAL FEATURES

- Features a durable finish and tear-resistant fabric.
- Includes metal adjustable-height handles.
- Pre-assembled for easy recessed or surface-mount installation without any cutting.

FRAME COLORS

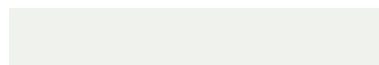

White

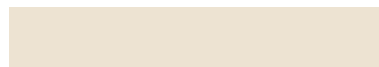

Almond



Desert Tan



Brownstone



Black

5 YEAR
LIMITED WARRANTY

CONFIGURATIONS

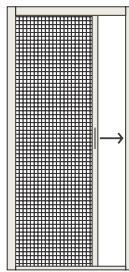

E100 Single

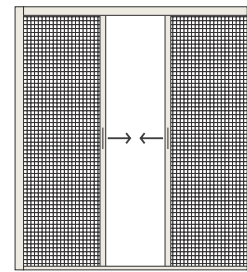
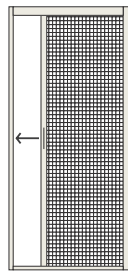

E200 Double

PROFILES

42.5 mm Cassette

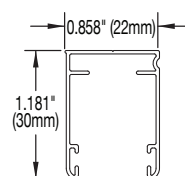
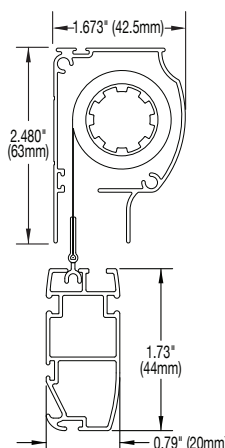

Top Profile

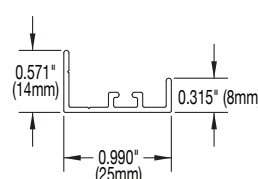

Side Profile

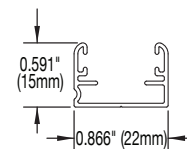

Bottom Guide

CONFIGURATION AVAILABILITY

ESCAPE E100 (Custom Sizes)	
WIDTH MIN-MAX	HEIGHT MIN-MAX
20" - 60"	36" - 84"
20" - 60"	84-1/8" - 96"

ESCAPE E200 (Custom Sizes)	
WIDTH MIN-MAX	HEIGHT MIN-MAX
30" - 96"	36" - 84"
30" - 96"	84-1/8" - 96"

SCREEN FABRIC OPTIONS (Apply to screen pricing listed above.)	
SCREEN FABRIC OPTION	SCREEN COLORS
BetterVue® Clear Visibility Screen Traditional Roller Style Screens: 60" Max Width per Panel Smooth-Glide Roller Style Screens: 66" Max Width / 36mm Cassette	Charcoal
17 x 20 Ultra Strength Screen 42" Max Width Per Panel	Black or White
Heavy-Duty PetScreen® 44" Max Width Per Panel	Charcoal
TuffScreen® No-See-Ums Fabric with Enhanced Solar Protection 56" Max. Width Per Screen Panel	Charcoal

AVAILABLE THRESHOLD TRANSITIONS (When ordered with the door screen.)	
SCREEN FABRIC OPTION	COLORS
(Larson recommends that you deduct 1/16" from height of the net screen opening when using a transition.)	
Narrow Threshold Transition with End Caps	Silver or Bronze
Medium Threshold Transition with End Caps	Silver or Bronze
Rubber "L" Bug Seal For Use in the Back Channel of the Screen Cassette (not installed)	
No Speed Reducer (Brake)	
Wind Pile Weather Strip in the Top Guide Rail	
Sloped Wedge Shim (12" each) For Use with Traditional 15mm x 22mm Bottom Guide	
Sloped Wedge Shim (12" each) For Use with Narrow Threshold Transition	
Sloped Wedge Shim (12" each) For Use with Medium Threshold Transition	
(Larson recommends that you deduct 1/8" from height of the net screen opening when using sloped wedge shims.)	

THRESHOLD TRANSITION KITS (2 pieces plus end caps per each kit.)			
TRANSITION STYLE	DESCRIPTION	PART # SILVER FINISH	PART # BRONZE FINISH
Narrow	2 Pieces 40" Long	06-01120-0-0	06-01120-1-2
	2 Pieces 72" Long	06-12010-0-0	06-12010-1-2
Medium	2 Pieces 40" Long	06-01130-0-0	06-01130-1-2
	2 Pieces 72" Long	06-12020-0-0	06-12020-1-2

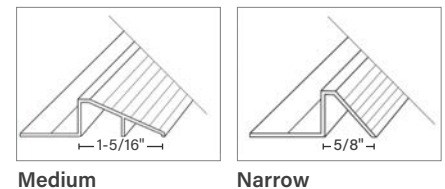

SPECIFY WHEN ORDERING

- A. Quantity
- B. Product Model (E100 or E200)
- C. Frame Color
- D. Mounting Type
 - a. Recess/Inset Mounted or
 - b. Surface/Face Mounted
- E. Net Screen Opening Size (Width x Height)
- F. Options (Specify any desired options or alternate screen fabric)

- Custom doors have extended, variable lead times. Once placed, custom orders cannot be canceled. All other orders can be canceled within the first 24 hours.

Measuring Guide

SINGLE PANEL DOOR SCREENS

Applies only to Escape® and Inspire® inside mount applications.

Measuring a typical hinged door for the net screen opening dimensions.

Begin by deciding where best to position the screen. The opening must be plumb, level and square, and the bottom guide of the retractable screen must rest on a flat, level and solid surface. Make any needed adjustments to the opening (or plan and allow for shimming) before measuring for the screen. Determine the **net screen opening dimension** (width x height) as measured from the outermost edges of where the retractable screen will rest. Screens are then made to fit these dimensions. Manufacturing tolerances are **plus or minus 1/16"**. We recommend that with inside-the-frame installations (**Option A or B**), you **deduct an additional 1/16"** from the width and height dimensions that you submit. This deduction ensures that the screen is not too tight in the opening during installation. If you plan on using shims or threshold transitions, be sure to also deduct appropriately for these. See the product model catalog pages and installation instructions for more detail.

Retractable Screen Products

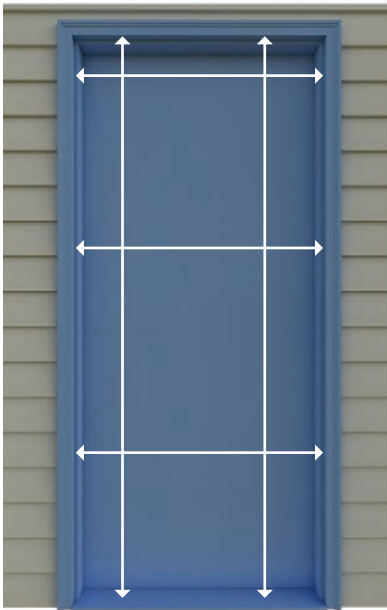

COMMON INSTALLATIONS

- OPTION A** Inside the Frame (Recess/Inset Mounted)
- OPTION B** Fully Inside the Frame (Recess/Inset Mounted)
- OPTION C** Outside the Frame (Surface/Face Mounted)

RECORD FINAL NET SCREEN OPENING DIMENSIONS

W _____

H _____

(If using installation Option A or B, **deduct 1/16"** from the width and height to order.)

OPTION A (Recommended)
INSIDE-THE-FRAME INSTALLATION
Recess Mounted at the Brickmould

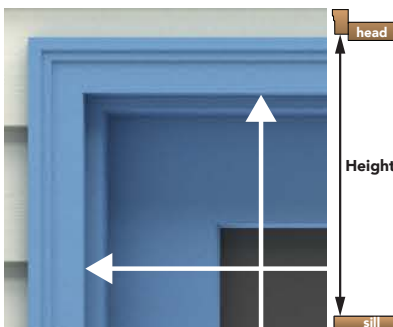
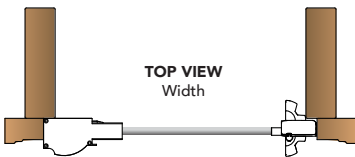

OPTION B
INSIDE-THE-FRAME INSTALLATION
Fully Inside the Master Frame

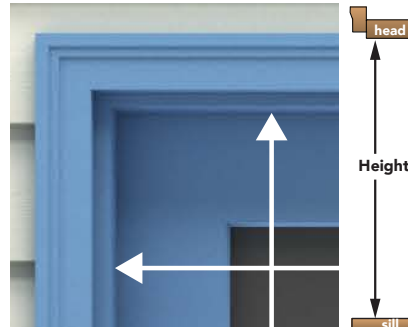
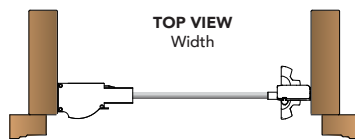

OPTION C
OUTSIDE-THE-FRAME INSTALLATION
Surface/Face Mounted

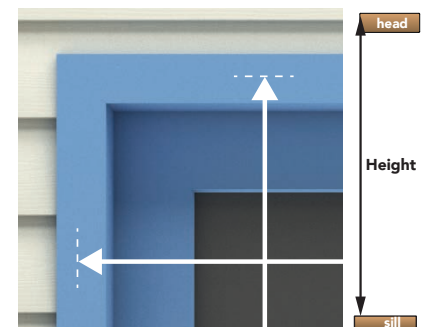
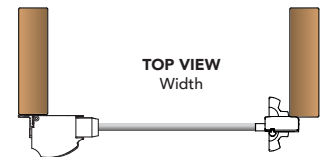

Measuring Guide

DOUBLE PANEL DOOR SCREENS

Applies only to Escape® and Inspire® inside mount applications.

Measuring a typical hinged double door for the net screen opening dimensions.

Begin by deciding where best to position the screen. The opening must be plumb, level and square, and the bottom guide of the retractable screen must rest on a flat, level and solid surface. Make any needed adjustments to the opening (or plan and allow for shimming) before measuring for the screen. Determine the **net screen opening dimension** (width x height) as measured from the outermost edges of where the retractable screen will rest. Screens are then made to fit these dimensions. Manufacturing tolerances are **plus or minus 1/16"**. We recommend that with inside-the-frame installations (**Option A or B**), you **deduct an additional 1/16"** from the width and height dimensions that you submit. This deduction ensures that the screen is not too tight in the opening during installation. If you plan on using shims or threshold transitions, be sure to also deduct appropriately for these. See the product model catalog pages and installation instructions for more detail.

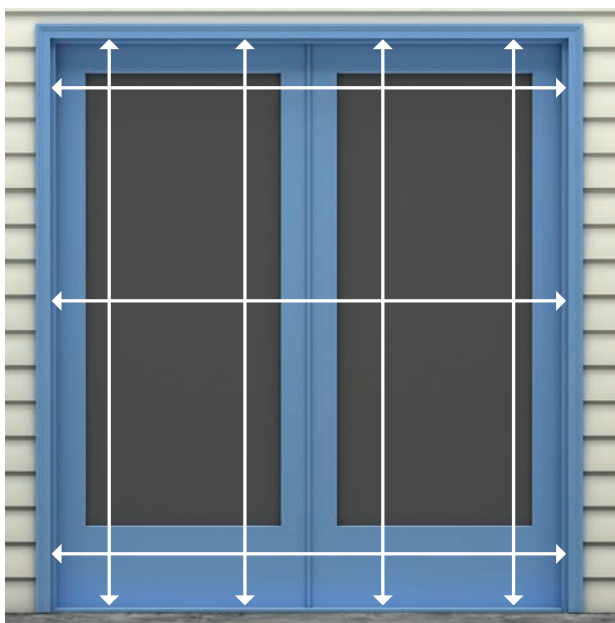

COMMON INSTALLATIONS

- OPTION A** Inside the Frame (Recess/Inset Mounted)
- OPTION B** Fully Inside the Frame (Recess/Inset Mounted)
- OPTION C** Outside the Frame (Surface/Face Mounted)

RECORD FINAL NET SCREEN OPENING DIMENSIONS

W _____

H _____

(If using installation Option A or B, **deduct 1/16"** from the width and height to order.)

Retractable Screen Products

OPTION A (Recommended)

INSIDE-THE-FRAME INSTALLATION
Recess Mounted at the Brickmould

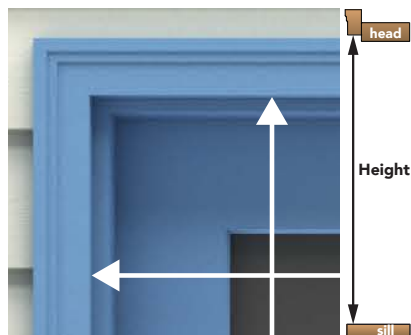
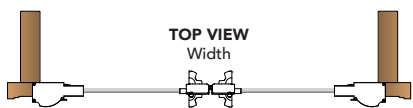

OPTION B

INSIDE-THE-FRAME INSTALLATION
Fully Inside the Master Frame

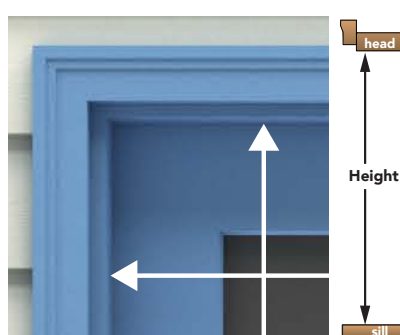
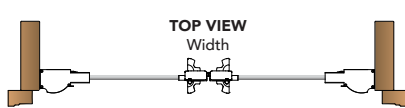

OPTION C

OUTSIDE-THE-FRAME-INSTALLATION
Surface/Face Mounted

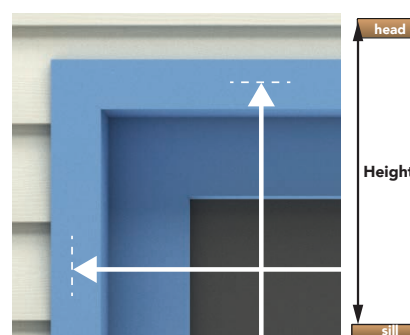
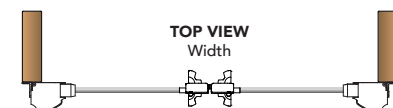

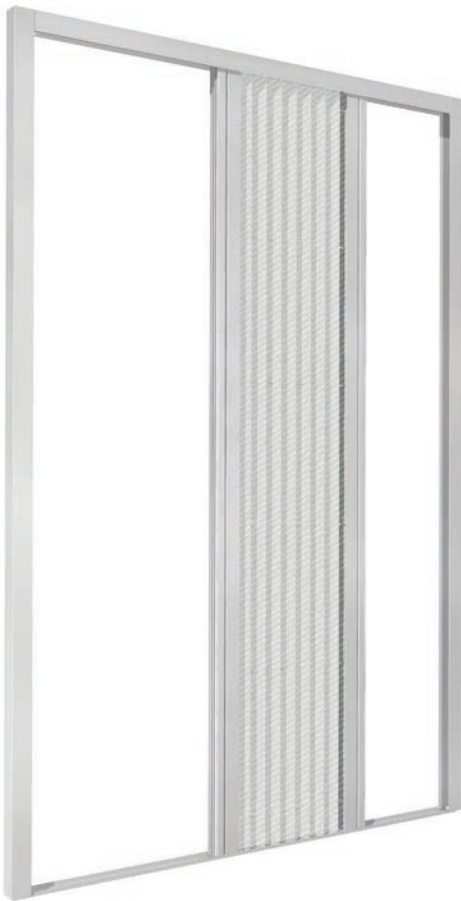

Retractable Wall Screen

WS1000 (Single), WS2000 (Double)

A NEW HORIZON FOR VENTILATION

The ideal screen solution for bi-folding, lift-n-slide and other large opening doors and windows, the Retractable Wall Screen fills the home with fresh air.

TOP BENEFITS



Fresh style. Elegant, pleated fabric provides ventilation with refined design.



Smooth operation. Easily move and stop the screen at any position with one hand.



Custom-made ventilation. Designed to fit openings up to 315" wide and 118" high.

ADDITIONAL FEATURES

- The single screen WS1000 can open from either end.
- The double screen WS2000 features two panels that meet in the middle.
- Pre-assembled for easy recessed installation.

FRAME COLORS

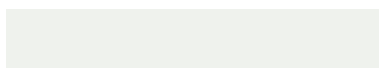

White



Desert Tan



Brownstone



Black

5 YEAR
LIMITED WARRANTY

CONFIGURATIONS

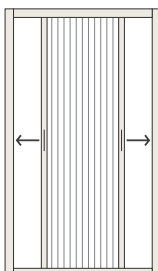

WS1000 Single

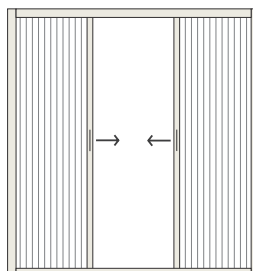

WS2000 Double

PRODUCT DETAILS

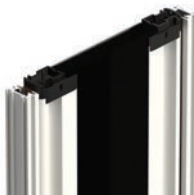

Screen Panel Assembly
WS1000 (qty. 1)



Screen Panel Assembly
WS2000 (qty. 2)



Top Guide



Side Profile



Bottom Guide

Note: See your Larson seller or visit larsondoors.com for details on limited warranties and exclusions. Not intended to keep children or pets inside. Product finish colors are approximate; actual finish colors may vary.

Right Page: Wall Screen WS1000 Single, Desert Tan Frame

PROFILES

MODEL - WS1000 (SINGLE)

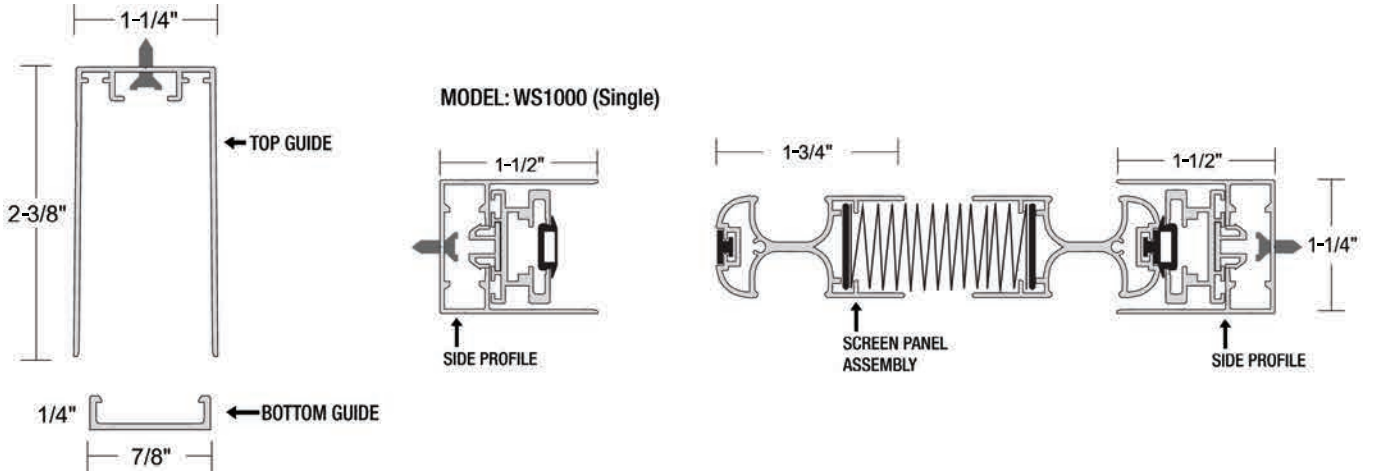

MODEL - WS2000 (DOUBLE)

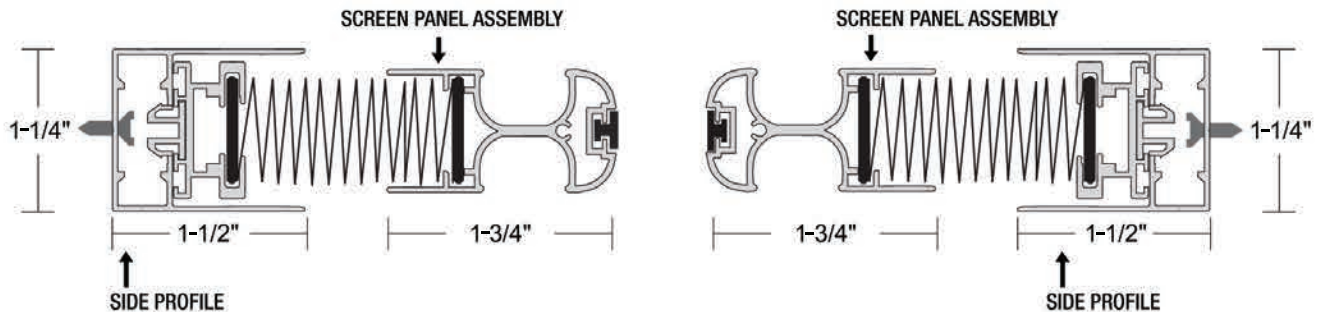

CONFIGURATION AVAILABILITY

WS1000 - SINGLE PANEL										
HEIGHT	114-1/8" - 118"	●	●	●	●	●				
	108-1/8" - 114"	●	●	●	●	●				
	102-1/8" - 108"	●	●	●	●	●	●			
	96-1/8" - 102"	●	●	●	●	●	●	●		
	72-1/8" - 96"	●	●	●	●	●	●	●	●	
	24" - 72"	●	●	●	●	●	●	●	●	●
UPTO	24" - 48"	48-1/8" - 72"	72-1/8" - 96"	96-1/8" - 120"	120-1/8" - 138"	138-1/8" - 154"	154-1/8" - 166"	166-1/8" - 177"		
WIDTH										
24" Minimum Width & Height Maximum Size 114.6 sq. ft. (W x H/144)										

WS2000 - DOUBLE PANEL												
HEIGHT	114-1/8" - 118"	●	●	●	●	●	●	●				
	108-1/8" - 114"	●	●	●	●	●	●	●	●			
	102-1/8" - 108"	●	●	●	●	●	●	●	●	●		
	96-1/8" - 102"	●	●	●	●	●	●	●	●	●	●	
	72-1/8" - 96"	●	●	●	●	●	●	●	●	●	●	●
	24" - 72"	●	●	●	●	●	●	●	●	●	●	●
UPTO	40" - 72"	72-1/8" - 96"	96-1/8" - 132"	132-1/8" - 168"	168-1/8" - 204"	204-1/8" - 240"	240-1/8" - 276"	276-1/8" - 300"	300-1/8" - 312"	312-1/8" - 315"		
WIDTH												
40" Minimum Width; 24" Minimum Height Maximum size 229-1/5 sq. ft. (W x H/144)												

SPECIFY WHEN ORDERING

- A. Quantity
- B. Product Model (WS1000 for Single Panel or WS2000 for Double Panel)
- C. Frame Color
- D. Net Screen Opening Size (Width x Height)

- Measuring & Installation: Designed to be installed within a framed opening (e.g., inset / recess mounted). 1-1/4" or deeper mounting surface required. Prior to measuring, be sure the opening is plumb, level and square and that the bottom guide has a flat, stable and smooth surface to rest on. Adjust the opening as needed.
- 2-piece top guide when over 180" wide.

Note: Extended lead times may apply.

Note: Larson retractable screens provide insect protection and support fresh, natural ventilation in low-wind conditions. Unlike 4-sided rigid framed screens, Larson retractable screens move in and out of a protective cassette, and the exposed surface area and edges of the fabric are flexible. Consequently, the wind speed that a retractable screen can withstand (e.g., before the edges of the screen fabric may push out of the guide rails) will depend on the width and height of the opening, the openness factor of the specific screen fabric and other design factors of the model. Retractable screens are not to be kept open or continually exposed to wind, sun, rain or other harsh conditions. Please be sure to use your retractable screen only during low-wind conditions.

Measuring Guide

WALL SCREEN AND INSPIRE (MULTI-PANEL) SCREENS

Measure for the net screen opening dimensions.

Begin by deciding where best to position the screen. The opening must be plumb, level and square, and the bottom guide of the retractable screen must rest on a flat, level and solid surface. Make any needed adjustments to the opening (or plan and allow for shimming) before measuring for the screen.

Determine the **net screen opening dimension** (width x height) as measured from the outermost edges of where the retractable screen will rest. Screens are then made to fit these dimensions. Manufacturing tolerances are **plus or minus 1/16"**. Because of this, we recommend that you **deduct an additional 1/16"** from the width and height dimensions that you submit in order to ensure that the screen is not too tight in the opening during installation.

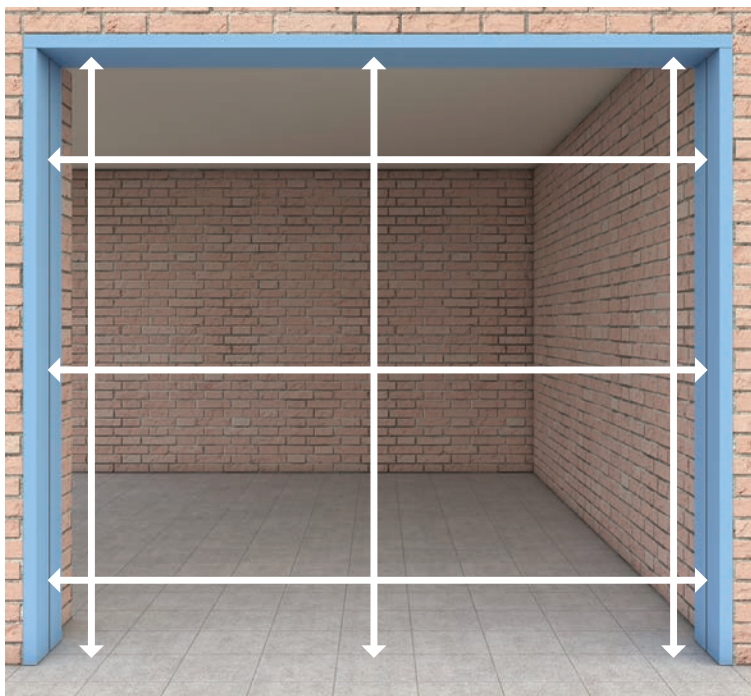

RECOMMENDED INSTALLATION TYPE

Inside-the-Frame Installation

(Recess / Inset Mounted)

RECORD FINAL NET SCREEN OPENING DIMENSIONS

W _____

H _____

(Deduct 1/16" from the width and height to order.)

BEFORE YOU MEASURE

Before measuring, ordering and installing the screen, ensure that the opening is plumb, level and square and that the bottom of the opening has a flat, stable and smooth mounting surface. If needed, add a metal strip or other material (sourced elsewhere) to create a suitable surface for mounting the bottom guide rail of the retractable screen.

EXAMPLES

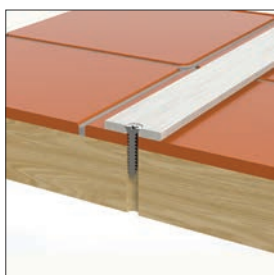

Uneven Tile Floor



Aggregate Cement Floor

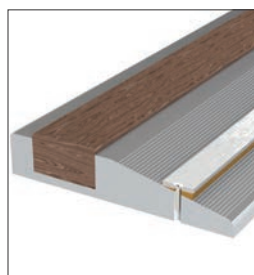

Angled Door Sill



Retractable Motorized Screen

Models 6+, 7+, 8+, 9+, 10+

ENJOY THE VIEW IN COMFORT

Protect against insects, debris, sun, heat and wind with the Larson® Retractable Motorized Screen and its selection of five purpose-built screens that fully retract for an unobstructed view.

TOP BENEFITS



Effortless operation. Conveniently raise and lower the screen with the push of a button on the remote — or let the automatic sun-wind sensor adjust the screen to match the weather.



Engineered endurance. The edge of the screen fabric is sonic welded to heavy-duty zipper tracks, sealing gaps on all sides and providing extra durability.



Custom-made solutions. Designed to fit openings up to 20' wide and 12' high, depending on screen type.



ALUMINUM FRAME COLORS

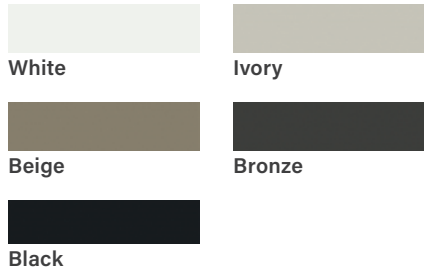

TUFFSCREEN. SCREEN COLORS



TUFFSCREEN. NO-SEE-UMS SCREEN COLORS



SUNTEX. 80 SCREEN COLORS

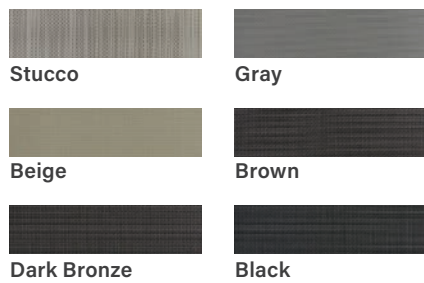

SUNTEX. 95 SCREEN COLORS

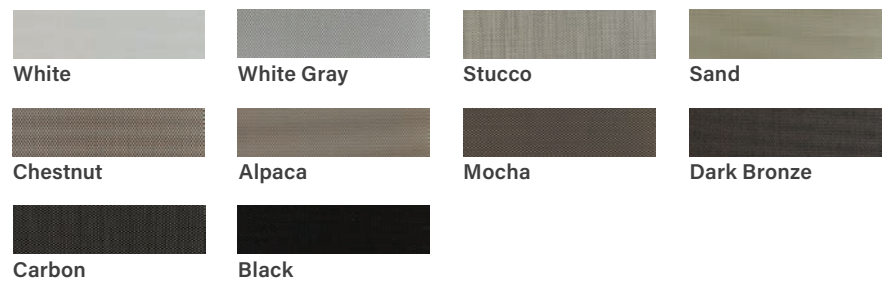

CLEAR VINYL WITH WEBLON. SURROUND COLORS



Note: See your Larson seller or visit larsondoors.com for details on available product sizes and options. Product finish colors are approximate; actual finish colors may vary. This is a motorized screen, which requires a separate power source to operate. The screen will not move up or down without power. We recommend that you purchase a backup power supply. Windy conditions may affect the performance of the screen. Retract the screen in windy circumstances, during inclement weather and when not needed to support immediate ventilation or prolonged periods of time when not used. Not intended to keep pets or children inside. This product contains one or more devices that comply with UL standards for electrical safety and with part 15 of FCC Rules for radio frequency devices.

Insect Screens

Experience outdoor living without the bugs. Insect screens safeguard against airborne pests and are made of durable, vinyl-coated polyester that resists tears and punctures.

TUFFSCREEN.

Protects against airborne pests.

TUFFSCREEN. NO-SEE-UMS

Protects against even the smallest airborne pests with a tighter weave.

CONFIGURATION AVAILABILITY

6+ INSECT SCREEN 4.5" CASSETTE Remote Sold Separately	
Height options are 1'-9' H	Width options are 3'-16' W and 16.5 W

Round up to next foot for accurate pricing (e.g., a 10'1" w x 8'2" h opening would be 11' w x 9' h).

7+ INSECT SCREEN 5.5" CASSETTE Remote Sold Separately	
Height options are 1'-12' H	Width options are 3'-20' W

Round up to next foot for accurate pricing (e.g., a 10'1" w x 8'2" h opening would be 11' w x 9' h).

Solar and Privacy Screens

Create a private getaway free from the heat of the sun and the gaze of your neighbors. Solar and privacy screens block the sun and its heat for cooler outdoor spaces with added privacy.

SUNTEX. 80

Provides approximately 75% UV blockage for shade and privacy.

SUNTEX. 95

Provides approximately 95% UV blockage for excellent shade and privacy.

CONFIGURATION AVAILABILITY

8+ SOLAR AND PRIVACY SCREEN 4.5" CASSETTE Remote Sold Separately	
Height options are 1'-9' H	Width options are 3'-16' W and 16.5 W

Round up to next foot for accurate pricing (e.g., a 10'1" w x 8'2" h opening would be 11' w x 9' h).

9+ SOLAR AND PRIVACY SCREEN 5.5" CASSETTE Remote Sold Separately	
Height options are 1'-12' H	Width options are 3'-20' W

Round up to next foot for accurate pricing (e.g., a 10'1" w x 8'2" h opening would be 11' w x 9' h).



Vinyl Screens

Transform outdoor spaces into multi-season rooms with the outstanding climate control of vinyl screens. A transparent plastic panel provides a view while the screen is down. Features your choice of colored fabric borders. **Heavy-duty bottom bar is included.**

CLEAR VINYL WITH WEBLON. SURROUND

Provides climate control to the enclosed space while a transparent plastic panel maintains the view.

CONFIGURATION AVAILABILITY

10+ VINYL SCREEN 5.5" CASSETTE Remote Sold Separately	
Height options are 1'-11' H	Width options are 3'-18' W

Round up to next foot for accurate pricing (e.g., a 10'1" w x 8'2" h opening would be 11' w x 9' h).

HAND-HELD REMOTES (All Remotes Are Purchased Separately)

Somfy 1 Channel Remote [Item 1810643]
(1 Channel controls 1 screen.)

Somfy 5 Channel Remote [Item 1810645]
(5 Channel controls up to 5 screens or groups of screens.)

Somfy 16 Channel Remote [Item 1811081]
(16 Channel controls up to 16 screens or groups of screens.)

Somfy Situo 5 Soliris Sun Sensor 5 Channel Remote [Item 1870579]
(Required to activate Sun Sensor option.)

HD BOTTOM BAR <small>(Option for 7+ and 9+ Models)</small>	OTHER ACCESSORIES
Under 155" in Width	Somfy Sun & Wind Sensor [Item 9012500]
Over 155" in Width	1" x 2" Angle (For use when inside mounting the screen.)
BOTTOM BAR SEAL REPLACEMENT PARTS	
Standard 1.5" Brush (Black)	2" x 2" Angle (For use when inside mounting the screen.)
Standard 2" Brush (Black)	Custom Frame Color (Standard RAL)
4" Rubber Seal (White, Black, Gray, Bronze, Ivory, Beige)	
6" Rubber Seal (Black or Gray)	Note: For items sold by foot or yard measurements, round up to the next even foot or yard.

Heavy-Duty Bottom Bar

Available for upgrade on 7+ and 9+ models for extra wind resistance. Standard on 10+ model.

Screen Controls

Conveniently raise and lower the screen with the push of a button on the remote; or let the automatic sun-wind sensor adjust the screen to match the weather.

SOMFY. REMOTE CONTROLS

Simultaneously operate up to 16 screens with the push of a button.

- 1 Channel controls 1 screen.
- 5 Channel controls up to 5 screens or groups of screens.
- 16 Channel controls up to 16 screens or groups of screens.

SOMFY. SUN-WIND SENSOR (Optional)

Automatically lowers up to 16 screens during intense sunlight and raises them during heavy winds.

PROFILES

Diagrams show models 6+ or 8+. Measurements are in inches.



Inside Mount

Scan the QR code to watch the installation video. These instructions describe an **inside or recessed** mount installation.



Outside Mount

Scan the QR code to watch the installation video. These instructions describe an **outside or surface** mount installation.

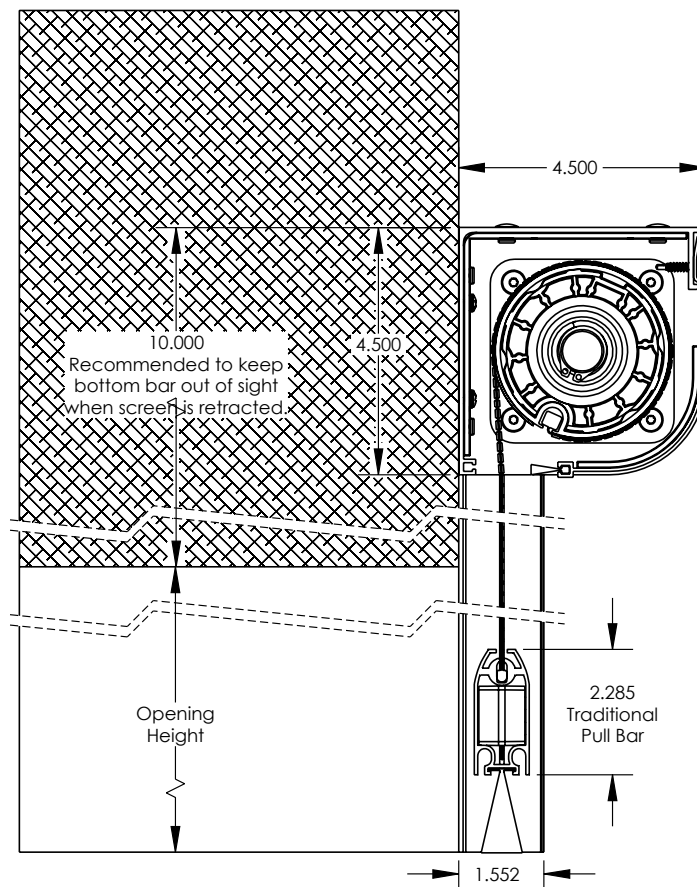
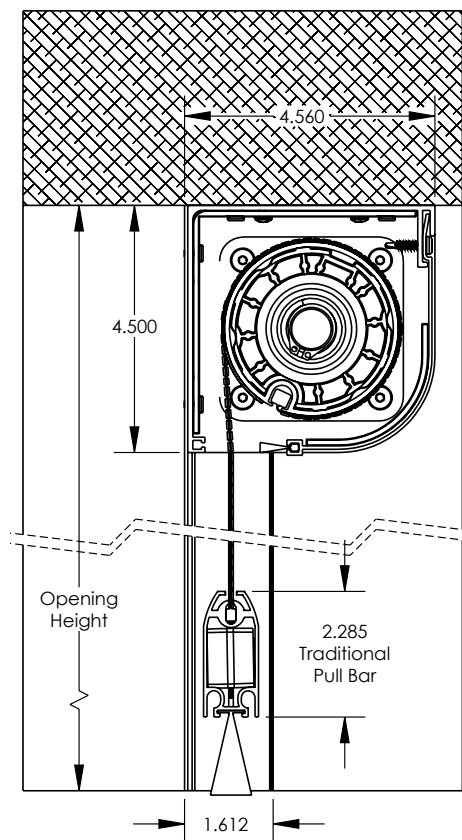

Measuring Guide

RETRACTABLE MOTORIZED SCREEN - INSIDE MOUNT

Use these instructions to measure your opening for an inside mount motorized screen.

Supply the final width and final height when ordering.

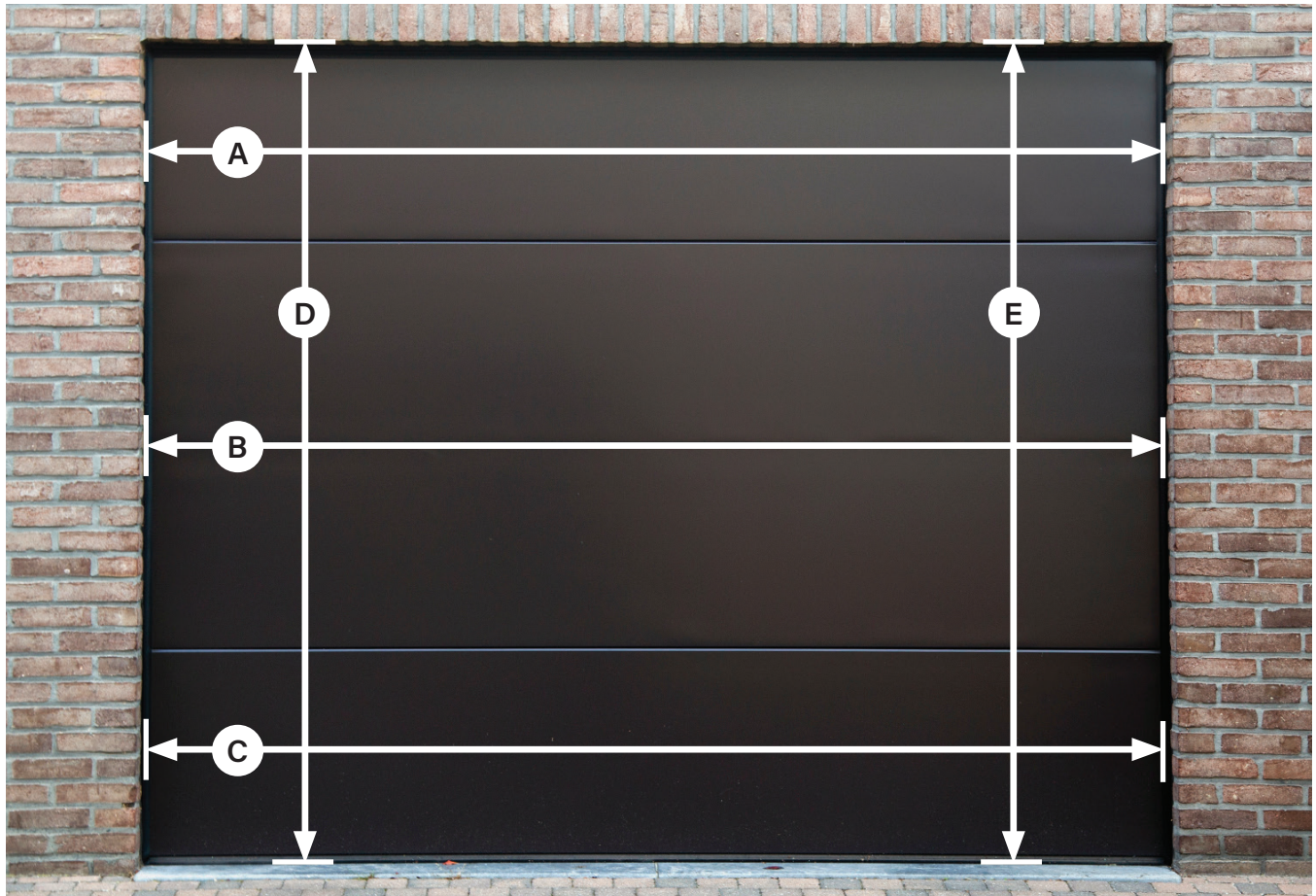

Retractable Screen Products

Measure distances **A**, **B** and **C** in inches and record below. Take the narrowest measurement and **subtract half an inch:**

This is your final width.

A	Width	B	Width	C	Width	Final Width	
----------	-------	----------	-------	----------	-------	-------------	--

Measure distances **D** and **E** in inches and record below.

The highest measurement is your final height.

D	Height	E	Height	Final Height	
----------	--------	----------	--------	--------------	--

Measuring Guide

RETRACTABLE MOTORIZED SCREEN - OUTSIDE MOUNT

Use these instructions to measure your opening for an outside mount motorized screen.

Supply the final width and final height when ordering.

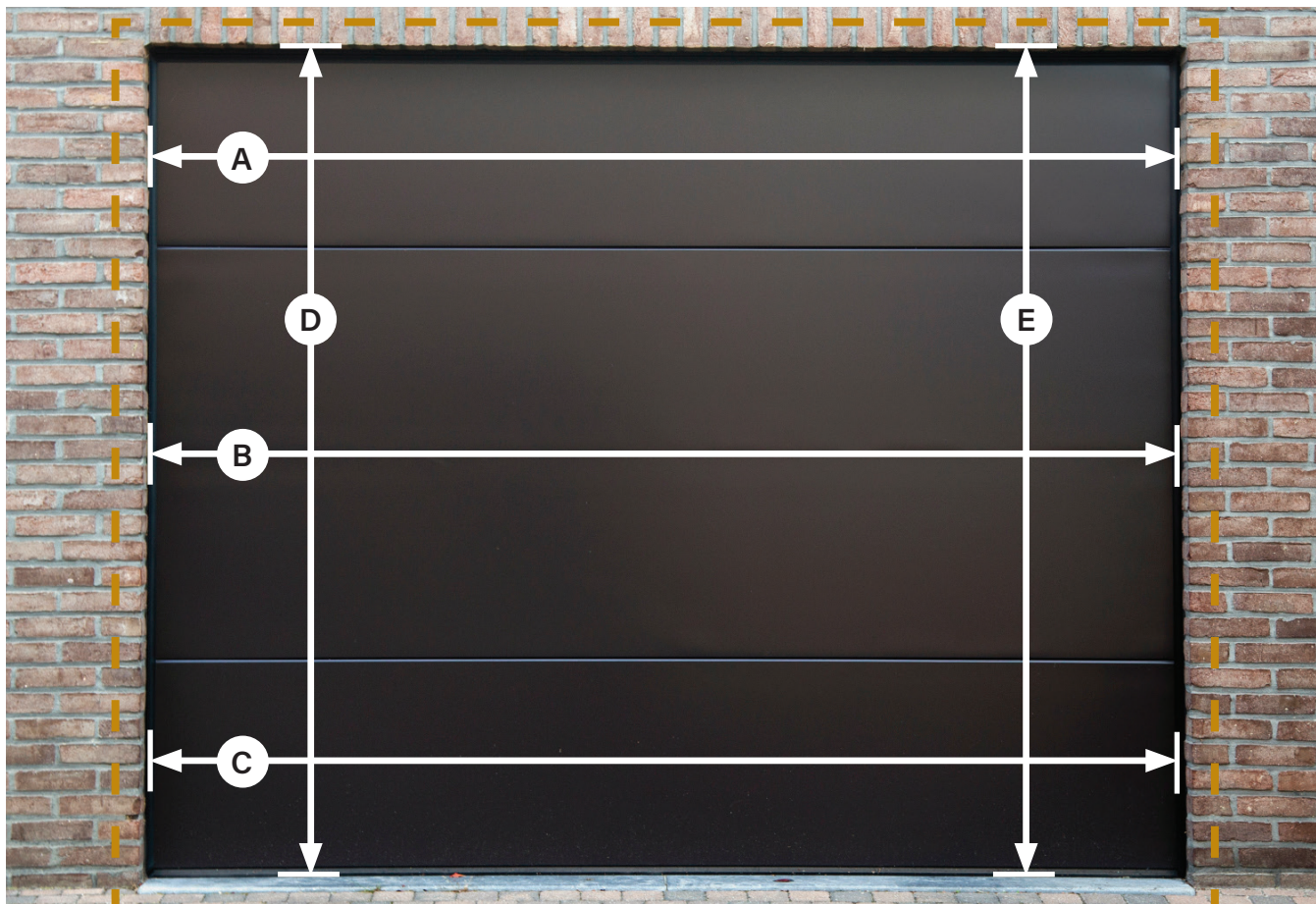

Measure distances **A**, **B** and **C** in inches and record below. Take the widest measurement and **add 5 inches:**

This is your final width.

Note: This will allow for the screen to be outside mounted without infringing on the daylight opening.

A	Width	B	Width	C	Width	Final Width	
----------	-------	----------	-------	----------	-------	-------------	--

Measure distances **D** and **E** in inches and record below. Take the highest measurement and **add 10 inches:**

This is your final height.

Note: This will allow for the housing and bottom bar to rest above the opening without infringing on the daylight opening. If there is a header, ceiling or other obstruction above the opening, you can add less than 10 inches to create the final height. However, this will cause the screen to infringe on the daylight opening.

D	Height	E	Height	Final Height	
----------	--------	----------	--------	--------------	--

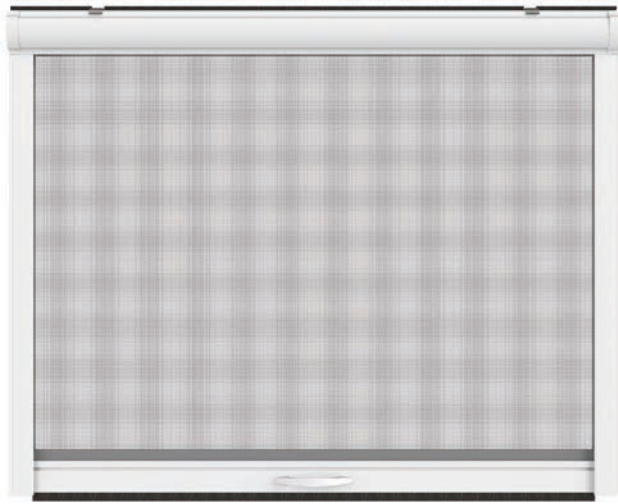

NatureVue Retractable Window Screen

NatureVue NV100

FRESH AIR IS ALWAYS IN REACH

Transform every window into an opportunity for ventilation using the NatureVue retractable window screen.

TOP BENEFITS



Worry-free ventilation. Screen provides bug-free air when you need it and retracts out of sight when you don't.



Custom-made ventilation. Designed for window openings up to 72" wide and up to 90" high.

FRAME COLORS

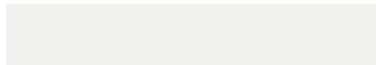

White

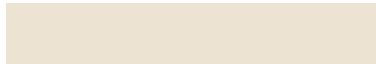

Almond



Desert Tan



Brownstone



Black



ADDITIONAL FEATURES

- Features a durable finish and BetterVue® fabric.
- A speed reducer provides controlled vertical retraction.
- Thick insect pile seals out insects.
- Includes a metal handle.
- Designed for easy recessed or surface mount installation.

CONFIGURATION AVAILABILITY

NATUREVUE NV100		
FINISH COLOR	WIDTH MIN-MAX	HEIGHT MIN-MAX
White	16-1/2" - 60"	12" - 72"
Almond	16-1/2" - 60"	72-1/8" - 90"
Desert Tan	60-1/8" - 72"	12" - 72"
Brownstone	60-1/8" - 72"	72-1/8" - 90"
Black	60-1/8" - 72"	72-1/8" - 90"

Measuring Guide

RETRACTABLE WINDOW SCREEN

Measuring for the net screen opening dimensions of a retractable window screen.

There are many different window frame designs and operation types, each with their own mounting requirements. Before measuring, determine the screen placement that will provide the best stability, operation and appearance. Window frame stylization and decorative mouldings may require that you install shims so that the screen can be installed in a stable, plumb and level manner.

Begin by determining the **net screen opening dimension** (width x height) as measured from the outermost edges of where the retractable screen will rest (**see Image A**). Screens are then made to fit the net screen opening dimensions. We recommend **deducting an additional 1/16"** from the width and height dimensions in order to ensure the screen is not too tight in the opening during installation.

All window screen orders **default to inside-the-frame (recessed) mounting** unless specifically noted that the screen will be used for **outside (surface) mounting**. When outside (surface) mounting a window screen, please note the type of mounting and then provide the net screen opening dimensions as defined as:

- Width: The tip-to-tip measurement of the final assembled screen cassette (**see Image A**).
- Height: The measurement from the outermost edge where the screen cassette will rest to the tip of the side guide rail end cap (**see Image A**).

The following illustrations show how to measure the net screen opening dimension of a retractable window screen.

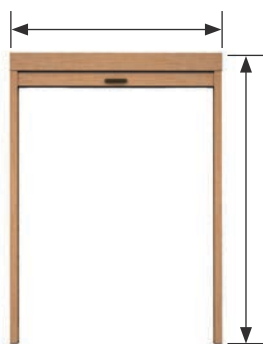

Image A

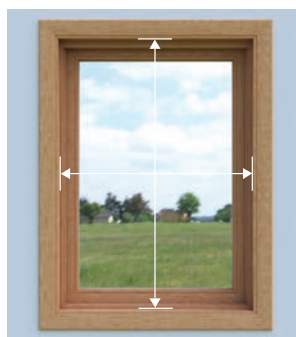

Image B

The NatureVue retractable window screen can be installed in one of two orientations so that the protruding area of the cassette faces away (most typical — **see Image C**), or toward the window frame (**see Image D**). The most typical way is for the protruding area of the cassette to face away from the frame. However, it can be useful to reverse the orientation of the cassette for aesthetic reasons or to avoid existing window hardware. For further detail, refer to the Larson installation instructions for the retractable window screen model.



Image C



Image D

Retail Hardware

Pneumatic Door Closers

Designed for outswing metal, wood or composite storm and screen doors.



White



Black

HEAVY-DUTY CLOSERS

CH1020306 & CH1020506

(Case of 6)

Measuring 12-5/8" center hole to center hole and 1-1/2" in diameter, the heavy-duty closer is built for single-closer use on medium- and heavy-weight doors. Includes mounting brackets and attaching hardware.

STANDARD-DUTY CLOSERS

CH1040306 & CH1040506

(Case of 6)

Measuring 12-5/8" center hole to center hole and 1-1/4" in diameter, the standard-duty closer is built for single-closer use on light- and medium-weight doors or for dual-closer use on heavy doors. Includes mounting brackets and attaching hardware.

STANDARD-DUTY CLOSERS WITH HOLD-OPEN FEATURE

CH1030306 & CH1030506

(Case of 6)

Measuring 12-5/8" center hole to center hole and 1-1/4" in diameter, the standard-duty closer is built for single-closer use on light- and medium-weight doors or for dual-closer use on heavy doors. Hold-open feature offers a hands-free way to keep the door open. Includes mounting brackets and attaching hardware.

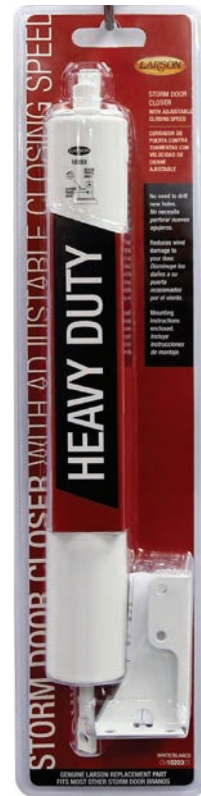

PART #	DESCRIPTION	FINISH	CASE QUANTITY (6 PER CASE)
CH1020306	Heavy-Duty Closer	White	1
CH1020506	Heavy-Duty Closer	Black	1
CH1040306	Standard-Duty Closer	White	1
CH1040506	Standard-Duty Closer	Black	1
CH1030306	Standard-Duty Closer with Hold-Open Feature	White	1
CH1030506	Standard-Duty Closer with Hold-Open Feature	Black	1

Note: Shipping and handling charges may apply. Requests to ship direct to a homeowner are subject to a shipping charge. Includes all products. Larson reserves the right to alter or discontinue any model, specification, warranty or price without notice. Product finish colors are approximate; actual finish colors may vary.

Retail Hardware Handlesets

Includes detailed instructions, mounting templates and all required installation hardware.



Brass



Brushed Nickel



Aged Bronze



REVERE MORTISE HANDLESETS

CH3040706, CH3041706 & CH3045706

(Case of 6)

This locking mortise handleset fits doors 1-1/8" to 2" thick with a 5/8" by 5-3/4" mortise hole. Comes with reversible levers for right- or left-handing.

PART #	FINISH	CASE QUANTITY (6 PER CASE)
CH3040706	Brass	1
CH3041706	Brushed Nickel	1
CH3045706	Aged Bronze	1

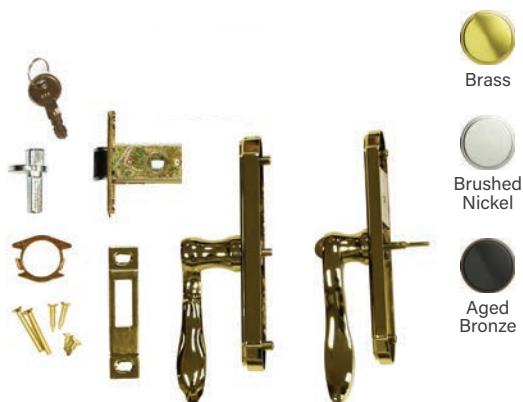

Brass



Brushed Nickel



Aged Bronze



M2 MORTISE HANDLESETS

CH3020706, CH3021706 & CH3025706

(Case of 6)

Made exclusively for Larson doors, this handleset fits doors 3/4" thick with a 9/16" by 1-1/8" mortise hole. Includes the added security of a keyed lock.

PART #	FINISH	CASE QUANTITY (6 PER CASE)
CH3020706	Brass	1
CH3021706	Brushed Nickel	1
CH3025706	Aged Bronze	1



White



Brass



GEORGIAN LEVER SURFACE MOUNTED HANDLESETS

CH3010306 & CH3010706

(Case of 6)

This classic Georgian surface mount handleset uses a single-piece face plate to replace existing hardware on most doors. Fits doors 3/4" to 1-1/8" thick with a 1-3/4" hole space.

PART #	FINISH	CASE QUANTITY (6 PER CASE)
CH3010306	White	1
CH3010706	Brass	1

Retail Hardware Handlesets

Includes detailed instructions, mounting templates and all required installation hardware.



EURO PUSH-BUTTON SURFACE MOUNTED HANDLESETS

CH2000306 & CH2000506
(Case of 6)

The elegant Euro push-button handleset fits doors 3/4" to 1-1/4" thick with a standard hole spacing of 1-3/4". Includes a color-matched surround plate and an interior paddle latch with a no-lockout feature.

PART #	FINISH	CASE QUANTITY (6 PER CASE)
CH2000306	White	1
CH2000506	Black	1



HEAVY-DUTY PUSH-BUTTON SURFACE MOUNTED KEYED HANDLESETS

CH2010306
(Case of 6)

This heavy-duty push-button handleset fits doors 3/4" to 1-1/4" thick with a standard hole spacing of 1-3/4". Includes a color-matched surround plate, keyed lock and interior paddle latch with a no-lockout feature.

PART #	FINISH	CASE QUANTITY (6 PER CASE)
CH2010306	White	1



EURO LIFT LEVER SURFACE MOUNTED HANDLESETS

CH4010306 & CH4010506
(Case of 6)

The smooth-action Euro lift lever handleset fits doors 3/4" to 1-1/4" thick with a standard hole spacing of 1-3/4". Includes a color-matched surround plate and interior paddle latch with a no-lockout feature.

PART #	FINISH	CASE QUANTITY (6 PER CASE)
CH4010306	White	1
CH4010506	Black	1

Retail Hardware

Wind Chains

Wind chains help to absorb some of the shock if the door suddenly blows open from high winds. If installed properly, this can potentially minimize damage to door closers, closer brackets and door hinges. Allows the door to open a full 90degrees.



Zinc



Black

STORM DOOR CHAIN CH9010106 & CH9010506 (Case of 6)



PART #	FINISH	CASE QUANTITY (6 PER CASE)
CH9010106	Zinc	1
CH9010506	Black	1

Door Sweeps

Includes two 38" long double-sweep pieces. Can be used to replace single sweeps for an even tighter seal. Fits all Larson storm doors manufactured after the year 2000. Not compatible with wood core doors with composite expanders.



STORM DOOR SWEEP CH9030506 (Case of 6)

PART #	FINISH	CASE QUANTITY (6 PER CASE)
CH9030506	Black	1



Replaces these profiles:



Note: Shipping and handling charges may apply. Requests to ship direct to a homeowner are subject to a shipping charge. Includes all products. Larson reserves the right to alter or discontinue any model, specification, warranty or price without notice. Product finish colors are approximate; actual finish colors may vary.

Parts & Accessories

Replacement Closer Kits & Miscellaneous Accessories

REPLACEMENT CLOSER KITS			
PART #	DESCRIPTION	COLOR	
202655xx	V920 Closer	White	Sandstone
		Almond	Brown
202665xx	V150 Closer	White	Sandstone
		Almond	Brown
202562xx	V920 Double Closer	White	Brown
		Almond	Black
		Sandstone	
202789xx	Two-Closer System 1 Step-to-Hold 1 Standard Closer	White	Brown
		Almond	Graphite
		Sandstone	Black
203000xx	150 Maximum View Closer Kit with SureLatch™	White	Bordeaux
		Almond	Graphite
		Sandstone	Black
		Brown	



V920 Closer

V150 Closer



V920 Double Closer

Two-Closer System



150 Maximum View
Closer with SureLatch

MISCELLANEOUS ACCESSORIES	
PRODUCT	PRODUCT
Hinge Rail	Touch Up Paint Bottle
Latch Rail	Touch Up Paint Spray
Drip Cap	Pet Flap - Medium #202821 8x12 (146PV)
Retainer Strip - Fullview	Pet Flap - Large #202746 10x17 (370-79, 360-79)
Aluminum Color-Matched Expander with Sweep	Pet Flap - XL #202728 14x23 (370-78)
White Vinyl Expander with Sweep	

EXPANDER SPLINES



PART #	2029498R	2029496R	2023197R	2023196R	202313	33923
--------	----------	----------	----------	----------	--------	-------

For discontinued or miscellaneous replacement parts, call Larson at 1-800-334-1328.

Note: Shipping and handling charges may apply. Requests to ship direct to a homeowner are subject to a shipping charge. Includes all products. Larson reserves the right to alter or discontinue any model, specification, warranty or price without notice. Product finish colors are approximate; actual finish colors may vary.

Parts & Accessories

Glass & Screen Inserts

When placing an order, please provide door color, size and model or tip-to-tip measurement of insert.

Registration number required for proper size and pricing.

GLASS INSERTS		
PRODUCT	PART #	GLASS TYPE
Maximum View Fixed Light	Specify Model	Plain
	Specify Model	Decorative
Maximum View Fixed Light Low-E	Specify Model	Plain
Fullview Fixed Light	Specify Model	Plain
	Specify Model	Decorative
Fullview Low-E	Specify Model	Low-E Glass
Highview Fixed Light	Specify Model	Plain
Midview	Specify Model	Plain
Highview		

SCREEN INSERTS			
MAXIMUM VIEW	FULLVIEW	MIDVIEW	HIGHVIEW

RETRACTABLE SCREEN REPLACEMENT KIT

Contains new screen tube with screen and spring unit and easy-to-follow installation instructions.

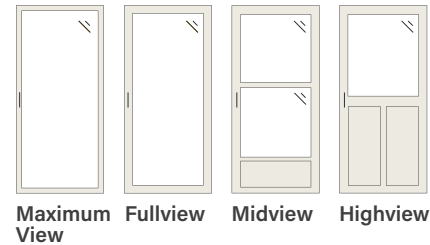

146 EASY VENT GLASS INSERTS			
OPTION	FULLVIEW	MIDVIEW	HIGHVIEW
146 Clear Glass			
Top Glass with Screen	●	●	●
Bottom Clear Glass (Pet Door Not Included)	●	●	
146 Low-E Glass			
Top Low-E Glass with Screen	●		
Low-E Bottom Glass	●		
146 Easy Vent Pet			
Top Glass with Screen	●		
Bottom Clear Glass with Pet Door (Available for Use on 146)	●		
146 Easy Vent Bevel Glass			
Top Bevel Glass with Screen	●		
Bottom Bevel Glass			

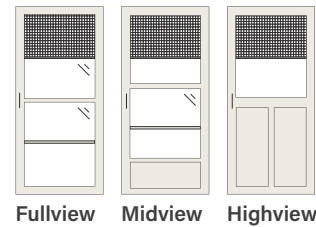

Parts & Accessories

Exterior/Interior Handlesets with Closer Kits



HANDLESET	SERIES / MODEL			PART #	COLOR / FINISH
 <p>Push-Button with Keyed Lock and FlexGuard Closer <i>Includes Flexguard Closers</i></p>	Reversa Screen 370-50			#20269103	White
				#20269104	Brown
 <p>Lever Surface Mount <i>Includes a V920 Closer</i></p>	Classic-View 360-16 360-48 360-79			#20298403	White
				#20298404	Brown
 <p>White or Black Push-Button <i>Includes a V920 Closer</i></p>	Lifestyle 830-46	Value-Core 380-05	Life-Core 298-SS	#202878103	White
				#202878105	Black
 <p>Modern Mortise Style Keyed <i>Secure Lock</i></p>	Lifestyle 2.0 370-84			#20281817	Brushed Nickel
 <p>Mortise Style Keyed <i>Secure Lock</i></p>	Lifestyle 691-90			#20275307	Brass
	Lifestyle 691-52			#20275317	Brushed Nickel
	Lifestyle 691-55			#20275357	Aged Bronze
 <p>Mortise Style <i>Secure Lock</i></p>	Lifestyle 830-80			#20275207	Brass
	Lifestyle 830-82			#20275217	Brushed Nickel
	Lifestyle 830-85			#20275257	Aged Bronze
 <p>Mortise Style Color-Match <i>Secure Lock</i></p>	Life-Core 278-SS 370-79 370-78			#20275203	White
				#20275204	Brown
				#20275208	Almond
				#20275209	Sandstone



For discontinued or miscellaneous replacement parts, call Larson at 1-800-334-1328.

¹Does not include lock body. Not for use on doors made prior to 2015 or without QuickFit lock body. QuickFit Blank Key is not applicable for Schlage or Kwikset option locks. Note: Storm doors more than 3 years old may require hardware substitutions. Shipping and handling charges may apply. Requests to ship direct to a homeowner are subject to a shipping charge. Includes all products. Larson reserves the right to alter or discontinue any model, specification, warranty or price without notice. Product finish colors are approximate; actual finish colors may vary.

Parts & Accessories

Exterior/Interior Handleset Kits

HANDLESET	SERIES / MODEL	PART #	COLOR / FINISH	REKEYABLE OUTSIDE TRIM PLATE ¹	
<p>Mortise Style Built-in Deadbolt</p> <p><i>Includes QuickFit Handleset and Replacement Instructions.</i></p> <p>QuickFit™</p> 	<p>Easy Vent Selection</p> <p>146FVE (Fullview Low-E) 146FV (Fullview) 146BV (Decorative Bevel) 146MV (Midview) 146HV (Highview) 146PV (Pet Door)</p>	Curved	#08716117	Brushed Nickel	<p>Optional to match Kwikset or Schlage entry door.</p> <p><i>Rekeying to be performed by locksmith.¹</i></p> 
			#08716157	Aged Bronze	
			#08716153	Matte Black	
			#08716107	Brass	
			#08716120	Antique Brass	
			#08719117	Brushed Nickel	
	Straight	<p>150 Maximum View Series</p> <p>150FX (Fullview) 150FXE (Fullview Low-E) 150BX (Decorative Bevel)</p>		#08719157	Aged Bronze
				#08719153	Matte Black
	<p>Platinum Collection</p> <p>456FV (Retractable Screen) 456FVE (Retractable Screen Low-E) 459FV (Interchangeable Screen) 459FVE (Interchangeable Screen Low-E) 450-18 (Secure Screen) 449-04 (Secure Glass)</p>				<p><i>*Curved only.</i></p> <p><i>Not available in White, Brown or Sandstone.</i></p>

HANDLESET	SERIES / MODEL	PART #	COLOR / FINISH
 <p>Mortise Style Built-in Deadbolt</p>	Classic-View 350-04	#08727207	Brass
	Classic-View 350-17	#08727217	Brushed Nickel
 <p>Surface Mount</p>	Lifestyle 356-60	#2026633	Brass
	Lifestyle 356-52	#2026683	Brushed Nickel

Sales Policy



Order the easy way at larsondoors.com/dealer.

For fast, convenient ordering, use the Larson Easy Ordering system. Enter orders on your own time with immediate confirmation of costs, freight information and ship dates. To get started, visit larsondoors.com/dealer and provide an email address along with business name, address and contact information. Or, email your account information to webdealers@larsondoors.com.

EMAIL & TELEPHONE ORDERS

1. Orders will be processed as given. Larson Manufacturing Company, LLC will not be held responsible for errors on email or phone orders.
2. An email confirmation of the order will be sent within a few hours. Please verify the information and call with any changes.
3. Review the order carefully. Orders for custom products may not be modified or canceled once they have been placed. Other orders may be canceled within the first 24 hours.

Note: Price pages are now separate from the Larson catalog. To access these pages digitally, please visit the Pro Center or contact our Customer Service team to order physical copies.

SHIPPING & HANDLING

Ground Delivery

Shipping and handling charges may apply. All products included.

RETURNS

For material shortages, errors or damaged or defective product, please notify our office immediately.

Pre-authorization of returns for credit is required for all standard size doors and subject to a 15% restocking charge. If product is returned on a carrier, a freight charge may also be assessed. Do not deduct any credits on returned merchandise from the invoice when remitting. Credit memos will be issued from our corporate office.

Note: Once placed, custom door orders cannot be canceled. For warranty questions, please visit larsondoors.com/warranty.

Dealer Line: 1-800-334-1328
Homeowner Helpline: 1-888-483-3768

Special project? We've got you covered.

Our team is ready to assist with your special requests, custom product orders and volume buys. Price quotes on all Larson[®] products are available for special building projects. Minimum quantities may apply. Stock replenishment excluded.

BULK & SPECIALITY ORDERS

To receive quotes for large quantity and specialty orders, email quotes@larsondoors.com.

STANDARD ORDER QUOTES

To receive quotes for non-specialty, low-volume orders, email dealerdirect@larsondoors.com or call 1-800-334-1328.



Helpful Resources

Warranty Documents

Enjoy with confidence. Find complete product and component warranties by scanning the QR code or visiting larsondoors.com/support/warranties.



Warranty Documents

Measuring Guides

Get the right fit. Use the measuring guides at the end of each product section to order the correct size for your project. Follow the index on the next page to quickly find the right guide. Find additional information about measuring for storm doors at larsondoors.com/project-center/how-to-use-a-tape-measure-for-storm-doors-diy-projects.

Replacement Parts

Missing or broken part? Find a replacement in pages 92–95 or order online at parts.larsondoors.com.

Customer Service

Need help? We have the expertise and resources to help you with all your product, installation or warranty questions. Visit us at larsondoors.com/support to explore our library of resources or to talk to us directly by phone or chat.

Index

STORM DOORS		RETRACTABLE SCREEN PRODUCTS	
146 Easy Vent Selection	20	E100 Escape Retractable Screen Door	70
150 Maximum View	23	E200 Escape Retractable Screen Door	70
278-SS Life-Core Single-Vent	38	IN100 Inspire Pleated Retractable Screen Door	68
298-SS Life-Core Composite Surface Single-Vent	40	NV100 NatureVue Retractable Window Screen	86
350 Classic-View Fullview	26	WS1000 Retractable Wall Screen	74
356 Lifestyle Fullview Screen Away	22	WS2000 Retractable Wall Screen	74
360-16/660-16 Classic-View Reversa Screen	36	FRENCH DOOR KITS	
360-48 WearTuff Full Screen	29	Opening Size Availability	42
360-49 Pet Breeze	33	Conversion Kits	43
360-79 Classic-View Pet View	32	MEASURING GUIDES	
370 Life-Core Pet Single-Vent	34	7721 Brisa Retractable Screen Door	63
370-50 Life-Core Reversa Screen	37	7722 Brisa Retractable Screen Door	65
370-84 Lifestyle 2.0 Midview Screen Away	31	7723 Brisa Retractable Screen Door	66
380-05 Mobile Home Single-Vent	39	Double Panel Door Screens	73
449 Platinum Secure Glass	14	Existing French Door Opening	45
450 Platinum Secure Screen	16	Platinum Collection	18
456 Platinum Retractable Screen	10	Retractable Motorized Screen – Inside Mount	84
459 Platinum Interchangeable Full Glass	12	Retractable Motorized Screen – Outside Mount	85
691 Lifestyle Highview Screen Away	30	Retractable Window Screen	87
830 Lifestyle Midview Screen Away	27	Security Round Tops	53
SECURITY STORM DOORS		Security Storm Doors	51
920-20 Courtyard	48	Single Panel Door Screens	72
920-21 Garden View	48	Universal-Hinged Storm Doors	41
920-24 Geneva	48	Wall Screen & Inspire Multi-Panel Screens	77
920-28 El Dorado	48	RETAIL HARDWARE	
920-36 SoHo	48	Door Sweeps	91
Security Round Top – Courtyard	52	Handlesets	89
Security Round Top – Fullview	52	Pneumatic Door Closers	88
RETRACTABLE SCREEN PRODUCTS		Wind Chains	91
6+ Retractable Motorized Screen	80	PARTS & ACCESSORIES	
7+ Retractable Motorized Screen	80	Expander Splines	92
8+ Retractable Motorized Screen	80	Exterior / Interior Handlesets	95
9+ Retractable Motorized Screen	80	Exterior / Interior Handlesets with Closer Kits	94
10+ Retractable Motorized Screen	82	Glass & Screen Inserts	93
7721 Brisa Retractable Screen Door	58	Miscellaneous Accessories	92
7722 Brisa Retractable Screen Door	58	Replacement Closers	92
7723 Brisa Retractable Screen Door	58		





STORM DOORS • SCREENS • PARTS & ACCESSORIES

LARSON

larsondoors.com

1-888-483-3768

1 Horizon Way
Deerfield, IL 60015



#larsondoors

Cover: 150 Maximum View, White, Curved Brass QuickFit™ Handleset
Back Cover: 459 Platinum Interchangeable Full Glass, Graphite

©2026 Larson Manufacturing Company, LLC. All rights reserved. LARSON and the Larson logo are trademarks of Larson Manufacturing Company, LLC. Registered trademarks are registered in the U.S. and may be registered internationally. Larson Manufacturing Company, LLC. is an operating company of Fortune Brands Innovations, Inc. All trademarks are property of their respective owners.

O25-451500 Part #0950950 SHERIDAN / JAN 2026